

يمكن تكوين مجموعات مختلفة باستخدام قاعدة التصميم الأساسية ومجموعة واسعة من العناصر

Various combinations can be configured using the basic design base and an extensive range of items



*Harmony* BS-TYPE

مصممة للبساطة مع التطور

DESIGNED FOR SIMPLICITY WITH SOPHISTICATION

5 colors available: white, gold, matte gold, chrome, and matte chrome.



المكونات المطورة حديثاً  
NEWLY-DEVELOPED COMPONENTS

Component base with a thin design to perfectly match the BS box.

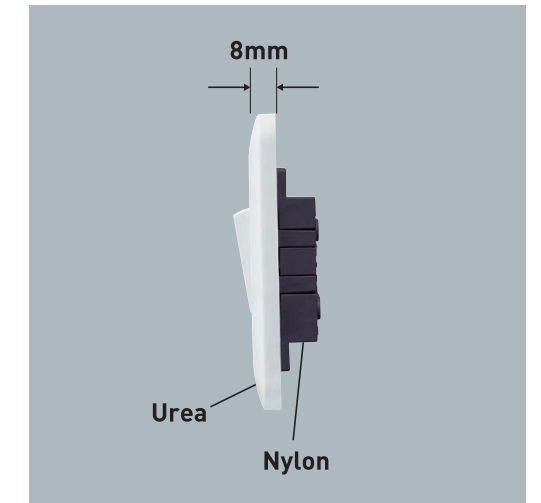

تحقيق الأمان من خلال الموثوقية العالية  
ACHIEVING SAFETY THROUGH HIGH RELIABILITY



Standard  
•BS/IEC Compliant







- European RoHS Directives compliant, totally free of Cd, Hg, Cr6+, Pb, PBBs, PBDEs, DIBP, DBP, BBP and DEHP substances.
- Fire-retardant materials used to prevent core components burning.
- Saudi Arabian Standards Organization (SASO) compliant.

# HARMONY BS-TYPE

★ Screw Terminal  
Please check applicable wires in technical details.

## اكسسورات Switches





<p><b>WBC5011</b> □□</p> <p>1-Gang 1Way SP Switch, 10AX 250V</p>  <p>★</p>	<p><b>WBC5021</b> □□</p> <p>1-Gang 2-Devices 1Way SP Switch, 10AX 250V</p>  <p>★</p>	<p><b>WBC5031</b> □□</p> <p>1-Gang 3-Devices 1Way SP Switch, 10AX 250V</p>  <p>★</p>	<p><b>WBC5041</b> □□</p> <p>2-Gang 4-Devices 1Way SP Switch, 10AX 250V</p>  <p>★</p>
---	---	---	---



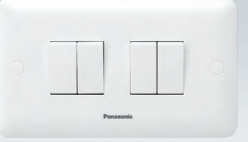

<p><b>WBC5203</b> □□</p> <p>1-Gang 20A DP Switch, 20A 250V</p>  <p>★</p>	<p><b>WBC5303</b> □□</p> <p>1-Gang 20A DP Switch with Indicator, 20A 250V</p>  <p>★</p>	<p><b>WBC5313</b> □□</p> <p>1-Gang 20A DP Switch Marked "Water Heater" with Indicator, 20A 250V</p>  <p>★</p>
---	--	--

<p><b>WBC5061</b> □□</p> <p>2-Gang 6-Devices 1Way SP Switch, 10AX 250V</p>  <p>★</p>	<p><b>WBC5012</b> □□</p> <p>1-Gang 1-Device 2Way SP Switch, 10AX 250V</p>  <p>★</p>	<p><b>WBC5022</b> □□</p> <p>1-Gang 2-Devices 2Way SP Switch, 10AX 250V</p>  <p>★</p>	<p><b>WBC5032</b> □□</p> <p>1-Gang 3-Devices 2Way SP Switch, 10AX 250V</p>  <p>★</p>
--	---	--	--

<p><b>WBC5403</b> □□</p> <p>1-Gang 45A DP Switch with Indicator, 45A 250V</p>  <p>★</p>	<p><b>WBC5413</b> □□</p> <p>2-Gang 45A DP Switch with Indicator Large plate, 45A 250V</p>  <p>★</p>	<p><b>WBC6120</b> □□</p> <p>2-Gang Cooker Control Unit (45A DP Switch, + 13A Socket DP Switched with Indicator) 13A 250V</p>  <p>★</p>
---	---	--

## مقابس Socket Outlets

<p><b>WBC5042</b> □□</p> <p>2-Gang 4-Devices 2Way 10A SP Switch, 10AX 250V</p>  <p>★</p>	<p><b>WBC5062</b> □□</p> <p>2-Gang 6-Devices 2Way SP Switch, 10AX 250V</p>  <p>★</p>	<p><b>WBC5014</b> □□</p> <p>1-Gang Intermediate Switch, 10AX 250V</p>  <p>★</p>	<p><b>WBC5511</b> □□</p> <p>1-Gang 1Way SP Push Switch, with "Bell Symbol" 10A 250V</p>  <p>★</p>
---	---	--	--

<p><b>WBC1212</b> □□</p> <p>1-Gang DP Switched Socket 13A 250V</p>  <p>★</p>	<p><b>WBC1214</b> □□</p> <p>1-Gang DP Switched Socket with Indicator 13A 250V</p>  <p>★</p>	<p><b>WBC1222</b> □□</p> <p>2-Gang DP Switched Socket 13A 250V</p>  <p>★</p>	<p><b>WBC1224</b> □□</p> <p>2-Gang DP Switched Socket with Indicator 13A 250V</p>  <p>★</p>
---	--	---	--

<p>الوان متنوعة Variety of Colors</p>					
	<p>White</p> <p>□□</p>	<p>Gold</p> <p>Y□</p>	<p>Matte-Gold</p> <p>Y Y</p>	<p>Chrome</p> <p>S□</p>	<p>Matte-Chrome</p> <p>S S</p>

S I M P L U S  
BS-TYPE

S I M P L U S  
BS-TYPE for Hotel

H A R M O N Y  
BS-TYPE

FULL-COLOR WIDE SIREIS  
for HOTEL

S I M P L U S  
BS-TYPE

S I M P L U S  
BS-TYPE for Hotel

H A R M O N Y  
BS-TYPE

FULL-COLOR WIDE SIREIS  
for HOTEL

HARMONY BS-TYPE

★ Screw Terminal  
Please check applicable wires  
in technical details.

<p><b>WBC1210 White only</b> <span style="color:red">NEW</span></p> <p>1-Gang Socket, Unswitched, 13A 250V</p>  <p>★</p>	<p><b>WBC1311</b> □□</p> <p>1-Gang SP Switched Socket 15A 250V</p>  <p>★</p>	<p><b>WBC1313</b> □□</p> <p>2-Gang SP Switched Socket with Indicator 15A 250V</p>  <p>★</p>	<p><b>WBC1410</b> □□</p> <p>1-Gang Socket 15A 127V</p>  <p>★</p>
---	---	--	---

<p><b>WBC1111</b> □□</p> <p>1-Gang SP Switched Socket 5A 250V</p>  <p>★</p>	<p><b>WBC1113</b> □□</p> <p>1-Gang SP Switched Socket with Indicator 5A 250V</p>  <p>★</p>	<p><b>WBC1510</b> □□</p> <p>1-Gang Universal Socket 16A 250V</p>  <p>★</p>	<p><b>WBC1520</b> □□</p> <p>1-Gang 2-Devices Universal Socket 16A 250V</p>  <p>★</p>
---	--	--	--

<p><b>WBC6122</b> □□</p> <p>1-Gang 1Way SP Switch 10AX 250V + 16A Universal Socket 16A 250V</p>  <p>★</p>	<p><b>WBC1610 White only</b></p> <p>1-Gang German Socket 16A 250V</p>  <p>★</p>	<p><b>WBC1711 White only</b></p> <p>1-Gang SP Switched Multiple Socket, 10A 250V</p>  <p>★</p>	<p><b>WBC9120</b> □□</p> <p>Shaver Socket Outlet Input : 220V-240V Output : 230V / 115V 20VA</p>  <p>★</p>
--	--	---	---

Accessories اكسسورات

<p><b>WBC3112</b> □□</p> <p>1-Gang Telephone Socket UK Master</p> 	<p><b>WBC3113</b> □□</p> <p>1-Gang Telephone Socket UK Secondary</p> 	<p><b>WBC3114</b> □□</p> <p>1-Gang Telephone Socket RJ11/12</p> 	<p><b>WBC3118</b> □□</p> <p>1-Gang Telephone Socket RJ11/12 6P4C</p> 
---	--	---	--

<p><b>WBC3124</b> □□</p> <p>1-Gang 2-Devices Telephone Socket RJ11/12</p> 	<p><b>WBC3128</b> □□</p> <p>1-Gang 2-Devices Telephone Socket RJ11/12 6P4C</p> 	<p><b>WBC3010</b> □□</p> <p>1-Gang TV Socket DIN Type</p> 	<p><b>WBC3011</b> □□</p> <p>1-Gang TV Socket F Type</p> 
--	---	--	--

<p><b>WBC3020</b> □□</p> <p>1-Gang TV Socket DIN Type + FM Socket</p> 	<p><b>WBC3818</b> □□</p> <p>1-Gang TV Socket F Type + Telephone Socket RJ11/12 6P4C</p> 	<p><b>WBC3822</b> □□</p> <p>1-Gang TV Socket F Type + Telephone Socket UK Master</p> 	<p><b>WBC3820</b> □□</p> <p>1-Gang TV Socket DIN Type + TV Socket F Type</p> 
---	---	--	--

الوان متنوعة  
Variety of Colors

  <p>White</p> <p>□□</p>	  <p>Gold</p> <p>Y□</p>	  <p>Matte-Gold</p> <p>Y Y</p>	  <p>Chrome</p> <p>S□</p>	  <p>Matte-Chrome</p> <p>S S</p>
--	---	--	---	--

S I M P L U S  
BS-TYPE

S I M P L U S  
BS-TYPE for Hotel

H A R M O N Y  
BS-TYPE

FULL-COLOR WIDE SIREIS  
for HOTEL

S I M P L U S  
BS-TYPE

S I M P L U S  
BS-TYPE for Hotel

H A R M O N Y  
BS-TYPE

FULL-COLOR WIDE SIREIS  
for HOTEL

# HARMONY BS-TYPE

★ **Screw Terminal**  
Please check applicable wires in technical details.

<b>WBC3821</b> □□ 1-Gang TV Socket DIN Type + Telephone Socket UK Master	<b>WBC3216</b> □□ 1-Gang CAT 5E RJ45	<b>WBC3217</b> □□ 1-Gang CAT 6 RJ45	<b>WBC3226</b> □□ 1-Gang 2-Devices CAT 5 RJ45
--	---	--	--

## Others اخرى

<b>WBC7010 White only</b> 1-Gang Cable Outlet with 20A Terminal Block	<b>WBC7020 White only</b> 1-Gang Cable Outlet with 45A Terminal Block	<b>WBC7100</b> □□ 1-Gang 13A Fused Connection Unit 13A 250V	<b>WBC7101</b> □□ 1-Gang 13A Fused Connection Unit with Indicator 13A 250V
--	--	--	---

<b>WBC3227</b> □□ 1-Gang 2-Devices CAT 6 RJ45	<b>WBC3878</b> □□ 1-Gang CAT 6 RJ45 + Telephone Socket RJ11/12 6P4C
--	---

<b>WBC7102</b> □□ 1-Gang 13A DP Switched Fused Connection Unit 13A 250V	<b>WBC7103</b> □□ 1-Gang 13A DP Switched Fused Connection Unit with Indicator 13A 250V	<b>WBC8010</b> □□ 1-Gang Blank Plate	<b>WBC8020</b> □□ 2-Gang Blank Plate
--	---	---	---

## ديمر لتحديد شدة الاضاءة Dimmer Switches

<b>WBC4211</b> □□ 1-Gang 2Way Push On/Off 500W Dimmer 220V-240V 50Hz/60Hz	<b>WBC4221</b> □□ 1-Gang 2-Devices 2Way Push On/Off 400W x 2 Dimmer 220V-240V 50Hz/60Hz	<b>WBC4231</b> □□ 2-Gang 3-Devices 2Way Push On/Off 350W x 3 Dimmer 220V-240V 50Hz/60Hz	<b>WBC4241</b> □□ 2-Gang 4-Devices 2Way Push On/Off 300W x 4 Dimmer 220V-240V 50Hz/60Hz
---	---	---	---

<b>WBC6010 White only</b> 1-Gang with Earth Terminal Box 35MM deep	<b>WBC6020 White only</b> 2-Gang with Earth Terminal Box 35MM deep
---	---

<b>الوان متنوعة Variety of Colors</b>	 <b>White</b> □□	 <b>Gold</b> Y□	 <b>Matte-Gold</b> Y Y	 <b>Chrome</b> S□	 <b>Matte-Chrome</b> S S
---	---	--	---	--	---

S I M P L U S  
BS-TYPE

S I M P L U S  
BS-TYPE for Hotel

H A R M O N Y  
BS-TYPE

FULL-COLOR WIDE SIREIS  
for HOTEL

S I M P L U S  
BS-TYPE

S I M P L U S  
BS-TYPE for Hotel

H A R M O N Y  
BS-TYPE

FULL-COLOR WIDE SIREIS  
for HOTEL

HARMONY BS-TYPE

Harmony

مفاتيح كهربائية 10 امبير  
Switches 10AX

BS-TYPE 1Way Switch

2Way Switch



WBC5011



WBC5021



WBC5031



WBC5061

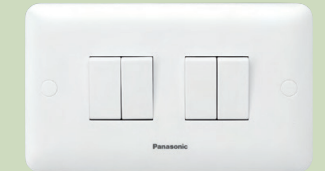

WBC5042

Technical Specifications الموصفات الفنية

- ▶ Standards  
Comply with BSEN60669-1
- ▶ Rating  
10AX 250V~
- ▶ Ambient Temperature  
-5°C – +40°C
- ▶ Representative Performance
  - Electric strength : 2,000V 1 min
  - Operation test : 40,000 Operations
  - Temperature rise : Test current 13.5A (2.5 mm<sup>2</sup>)  
Not more than 45K (Terminals)
- ▶ Terminal  
Pillar Terminal
- ▶ Applicable Wire  
1 mm<sup>2</sup> - 4 mm<sup>2</sup>
- ▶ Terminal Capacity  
1.5 mm<sup>2</sup> × 3  
2.5 mm<sup>2</sup> × 2  
4 mm<sup>2</sup> × 1

Features المميزات

- Compact tumbler switch delivers a distinct click feel.
- Made with flame-retardant and heat-resistant urea resins.
- Construction integrated with plate maintains overall compact dimensions.
- Accepts wires : 1 mm<sup>2</sup> - 4 mm<sup>2</sup> solid wire and stranded wire.

Dimensions الأبعاد

BS-TYPE 1Way Switch

2Way Switch

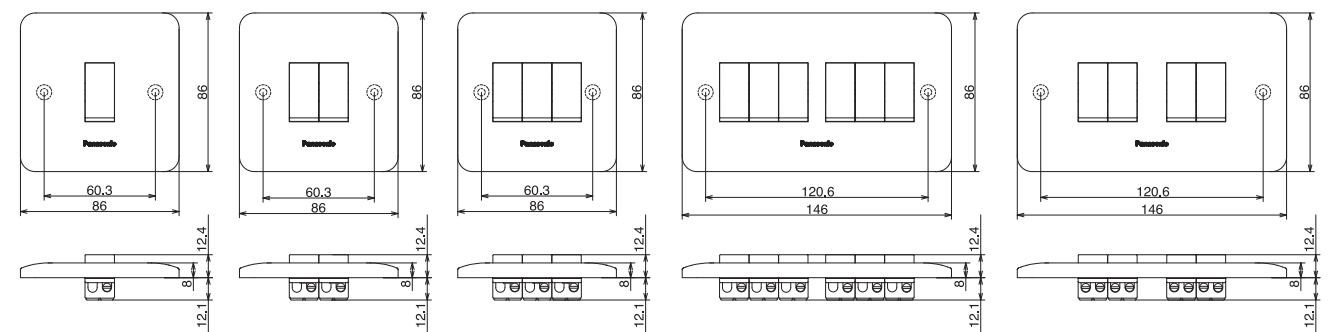

\*BS-TYPE : M3,5 mounting screws included.

HARMONY BS-TYPE



مفاتيح كهربائية 20 امبير  
Switches 20A

BS-TYPE DP Switch



WBC5203

DP Switch with Indicator



WBC5303

(Water Heater)



WBC5313

Technical Specifications الموصفات الفنية

- ▶ Standards  
Comply with BSEN60669-1
- ▶ Rating  
20A 250V~
- ▶ Ambient Temperature  
-5°C – +40°C
- ▶ Representative Performance
  - Electric strength : 2,000V 1 min
  - Operation test : 10,000 Operations
  - Temperature rise : Test current 25A (4 mm<sup>2</sup>)  
Not more than 45K (Terminals)
- ▶ Terminal  
Pillar Terminal
- ▶ Applicable Wire  
2.5 mm<sup>2</sup> - 6 mm<sup>2</sup>
- ▶ Terminal Capacity
  - 1.5 mm<sup>2</sup> × 3
  - 2.5 mm<sup>2</sup> × 3
  - 4 mm<sup>2</sup> × 2
  - 6 mm<sup>2</sup> × 1

Features المميزات

- High-capacity silver contact for longer life.
- Made with flame-retardant and heat-resistant urea resins.
- Construction integrated with plate maintains overall compact dimensions.
- Built-in lighted indicator shows On/Off status. (WBC 5303, 5313)

Dimensions الأبعاد

BS-TYPE DP Switch

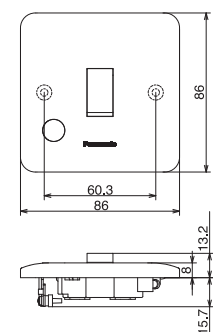

DP Switch with Indicator

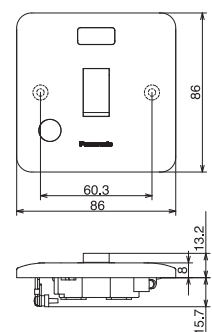

(Water Heater)

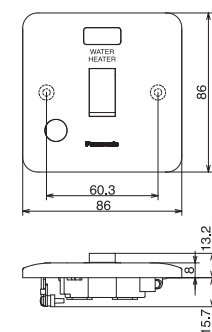

\*BS-TYPE : M3.5 mounting screws included.

HARMONY BS-TYPE



مفاتيح كهربائية 45 امبير  
Switches 45A

BS-TYPE DP Switch with Indicator



WBC5403



WBC5413

Technical Specifications الموصفات الفنية

- ▶ Standards  
Comply with BSEN60669-1
- ▶ Rating  
45A 250V~ (for a resistive circuit)  
25A 250V~ (for a motor-load circuit)
- ▶ Ambient Temperature  
-5°C – +40°C
- ▶ Representative Performance
  - Electric strength : 1,500V 1 min
  - Operation test : 10,000 Operations
  - Temperature rise : Test current 51A (16 mm<sup>2</sup>)  
Not more than 45K (Terminals)
- ▶ Terminal  
Pillar Terminal
- ▶ Applicable Wire  
4 mm<sup>2</sup> - 16 mm<sup>2</sup> Stranded wire  
4 mm<sup>2</sup> - 6 mm<sup>2</sup> Solid wire
- ▶ Terminal Capacity
  - 4 mm<sup>2</sup> × 3
  - 6 mm<sup>2</sup> × 2
  - 10 mm<sup>2</sup> × 1
  - 16 mm<sup>2</sup> × 1

Features المميزات

- High-capacity silver contact for longer life.
- Cover uses flame-retardant and heat-resistant urea resin. (body made from PBT)
- Construction integrated with plate maintains overall compact dimensions.
- Accepts wires : 4 mm<sup>2</sup> - 16 mm<sup>2</sup> solid wire and stranded wire.
- Built-in lighted indicator shows On/Off status.
- Normal gap double-pole switch (minimum contact gap : 3 mm) construction ensures safe load shut-off.

Dimensions الأبعاد

BS-TYPE DP Switch with Indicator

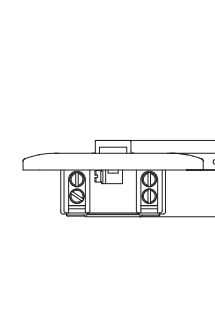
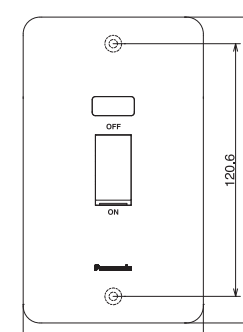
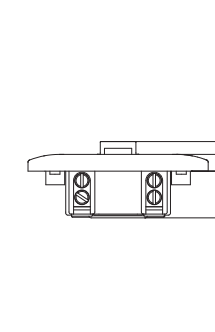
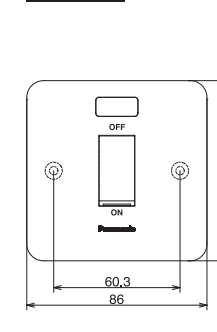

\*BS-TYPE : M3.5 mounting screws included.

HARMONY BS-TYPE



ديمر لتحديد شدة الاضاءة  
Dimmer Switches



HARMONY BS-TYPE



مقابس  
Socket Outlets

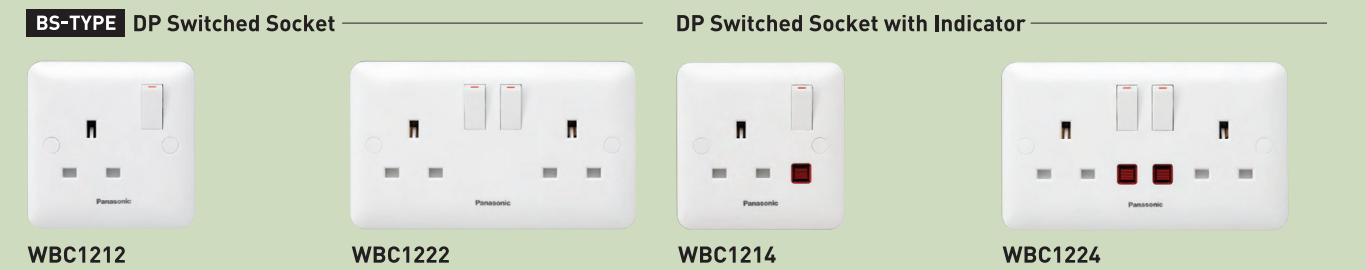

Technical Specifications الموصفات الفنية

- Rating: 220V-240V~50/60Hz
- Ambient Temperature: -5°C - +40°C
- Terminal: Pillar Terminal
- Applicable Wire: 1 mm<sup>2</sup> - 4 mm<sup>2</sup>

Features المميزات

- Product range extensive enough to include a 4-gang switch with 1,200W rating.
- Built-in Push On/Off function.
- Construction integrated with plate maintains overall compact dimensions.
- Fan controller available. (WBC4530)

Dimensions الأبعاد

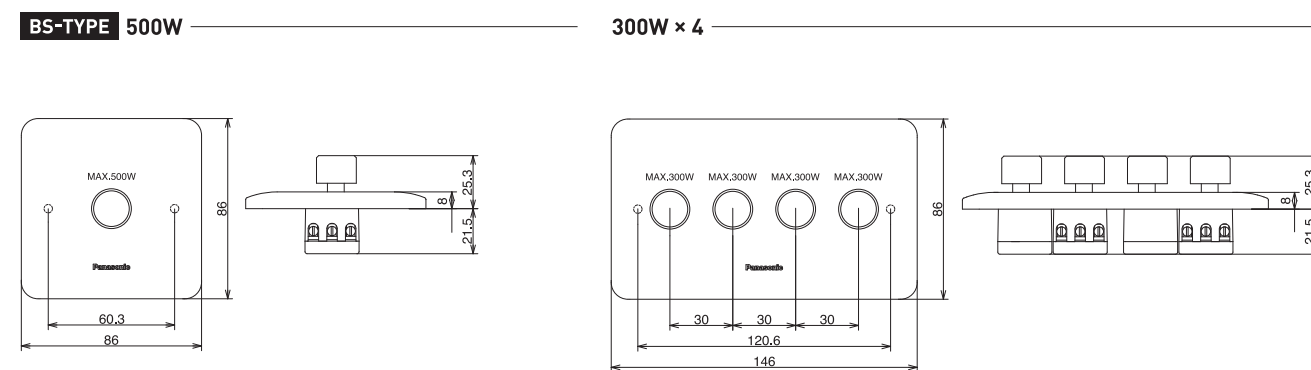

\*BS-TYPE : M3.5 mounting screws included.

Technical Specifications الموصفات الفنية

- Standards: Comply with BS1363-2
- Rating: 13A 250V~
- Ambient Temperature: -5°C - +40°C
- Representative Performance:
  - Electric strength : 2,000V 1 min
  - Operation test : 15,000 times (30,000 movements)
  - Temperature rise : Test current 20A (2.5 mm<sup>2</sup>) Not more than 52K (Terminals)
- Terminal: Pillar Terminal
- Applicable Wire: 1.5 mm<sup>2</sup> - 4 mm<sup>2</sup>, 15 AWG - 12 AWG
- Terminal Capacity:
  - 1.5 mm<sup>2</sup> x 3
  - 2.5 mm<sup>2</sup> x 3
  - 4 mm<sup>2</sup> x 2

Features المميزات

- Socket Outlet with a double-pole switch completely isolates load from power supply.
- Socket Outlet housing uses flame-retardant and heat-resistant Nylon with high anti-tracking properties.
- Accepts wires : 1.5 mm<sup>2</sup> - 4 mm<sup>2</sup> solid wire and stranded wire.
- Both socket and switch components have adequate operation capability.
- Included safety shutter prevents kids from tampering with socket.
- Models equipped with pilot lamps are also available. (single switch - 1 lamp, double switch - 2 lamps)

Dimensions الأبعاد

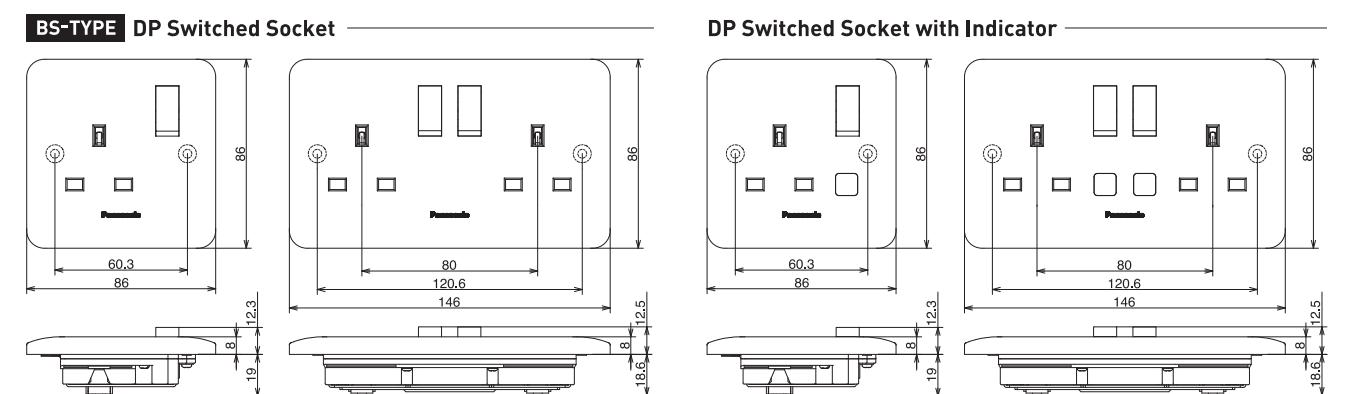

\*BS-TYPE : M3.5 mounting screws included.

HARMONY BS-TYPE



اكسسورات TV  
Accessories - Television



HARMONY BS-TYPE



اكسسورات هاتف  
Accessories- Telephone

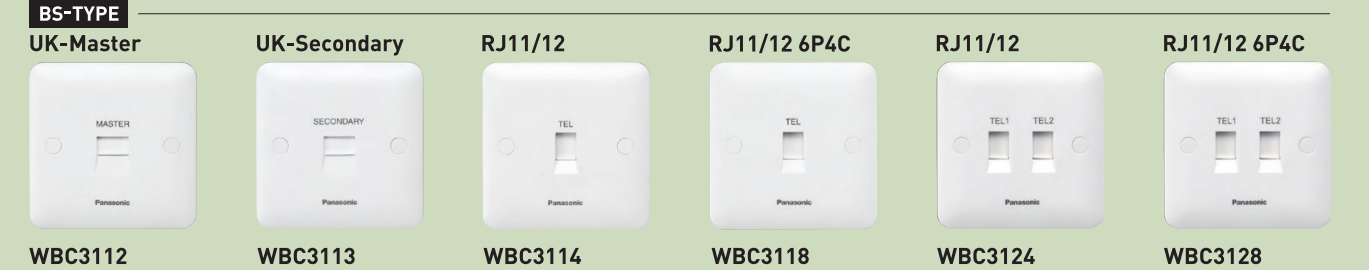

Technical Specifications الموصفات الفنية

- ▶ Connector Type (Outlet) : DIN Type  
WBC3010, WBC3020 (TV, FM), WBC3820 (TV)
- ▶ Terminal Screw Terminal
- ▶ Impedance Input, Outlet : 75Ω
- ▶ Applicable Cable Coaxial cable  
Characteristic Impedance  
75Ω type : CT-100 (or equivalent)
- ▶ Connector Type (Outlet) : F Type  
WBC3011 (SAT), WBC3820 (SAT)

Features المميزات

“Easy Connection” Connection just needs a coaxial cable to be inserted, then both core and braid sections are tightened with screws.

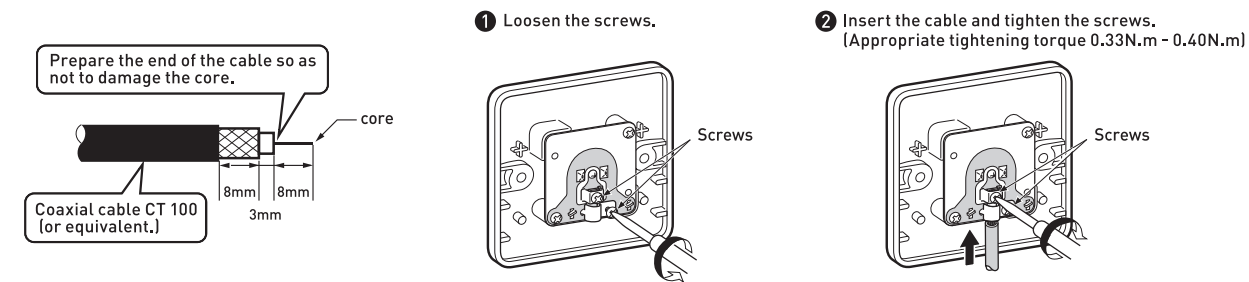

Dimensions الأبعاد

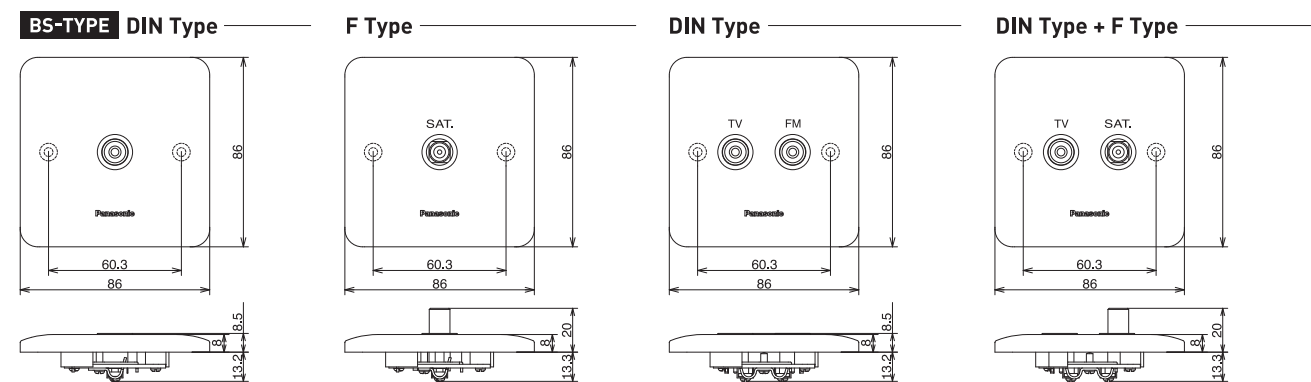

\*BS-TYPE : M3.5 mounting screws included.

Technical Specifications الموصفات الفنية

- ▶ Connector Type Miniature Modular Jack, 6P6C  
(Mechanically complies with BS 6312 : 1994, miniature 6 position jack with 6 contacts)
- ▶ Terminal Screw Terminal
- ▶ Applicable Wire Core wire to be 0.5 mm in diameter (solid copper only)  
2 Pairs Cable (CW1308)
- ▶ Connector Type Miniature Modular Jack, (6P2C) 6 position with 2-contacts, (6P4C) 6 position with 4-contacts, specified in TIA-1096-A (Previously in FCC part 68)
- ▶ Terminal Screw Terminal
- ▶ Applicable Wire Core wire to be 0.5 mm in diameter (solid copper only)

Features المميزات

- Using terminal blocks enhance wiring ease.
- Two types available-the RJ type and the UL type.

Dimensions الأبعاد

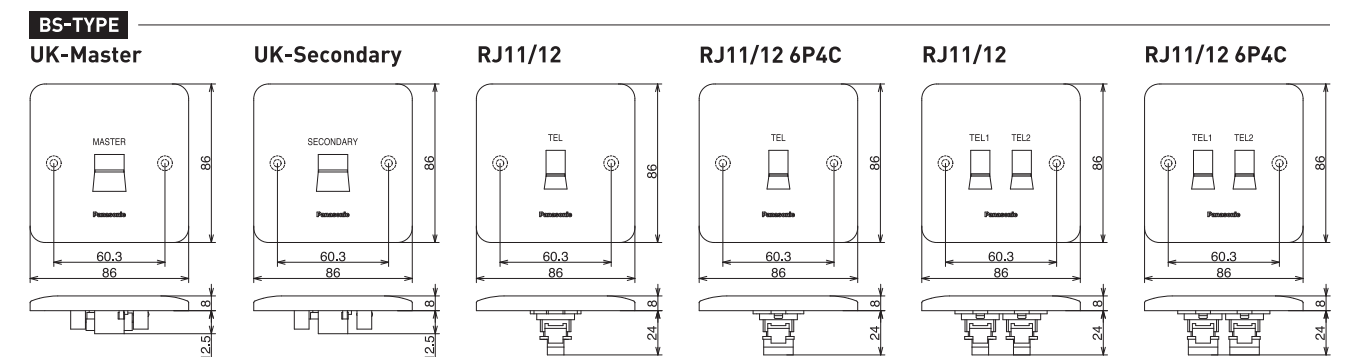

\*BS-TYPE : M3.5 mounting screws included.



HARMONY BS-TYPE



اكسسورات انترنت  
Accessories - LAN

BS-TYPE RJ45 Category 5e

RJ45 Category 6



WBC3216



WBC3226



WBC3217



WBC3227

Technical Specifications الموصفات الفنية

- ▶ Connector Type  
"8-way unshielded fixed connector (miniature 8-position modular jack)" specified in IEC 60603-7
- ▶ Terminal  
IDC connection
- ▶ Applicable Cable  
WBC3216/3226 : 4-pair UTP cable, Category 5e  
Conductor : solid copper wire, 22 AWG - 24 AWG (diameter : 0.5 mm - 0.65 mm)  
: or stranded copper wire, 24 AWG  
WBC3217/3227 : 4-pair UTP cable, Category 6  
Conductor : solid copper wire, 22 AWG - 24 AWG (diameter : 0.5 mm - 0.65 mm)

Features المميزات

1 It's not necessary to use special wiring tool.

2 No need to untwist the wires.

Pin/Pair assignment

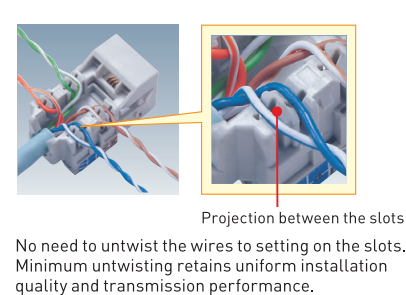
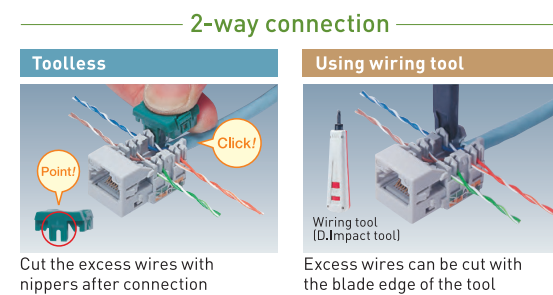

Pair	Color	Pin No.	
		T568A	T568B (Optional)
1	W/BL BL	5 4	5 4
2	W/O O	3 6	1 2
3	W/G G	1 2	3 6
4	W/BR BR	7 8	7 8

Dimensions الأبعاد

BS-TYPE RJ45 Category 5e

RJ45 Category 6

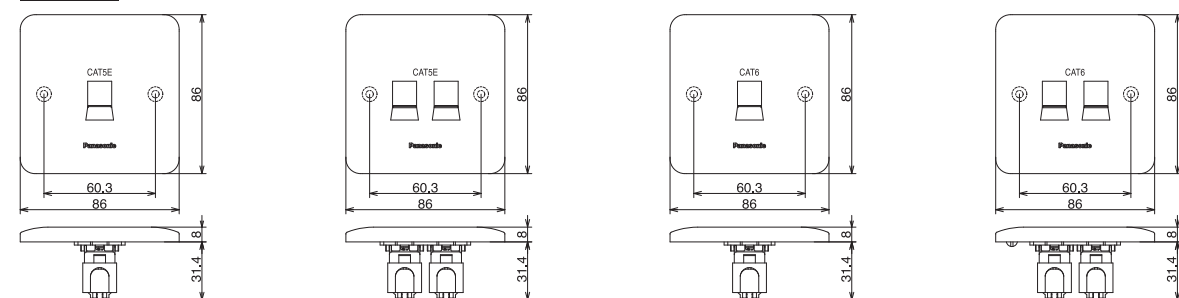

\*BS-TYPE : M3.5 mounting screws included.

HARMONY BS-TYPE



اخرى  
Others

Push Button



WBC5511

Technical Specifications الموصفات الفنية

- ▶ Standards  
Comply with BSEN60669-1
- ▶ Rating  
10A 250V~
- ▶ Ambient Temperature  
-5°C - +40°C
- ▶ Representative Performance  
· Electric strength : 2,000V 1 min  
· Operation test : 40,000 Operations  
· Temperature rise : Test current 13.5A [2.5 mm<sup>2</sup>]  
Not more than 45K (Terminals)
- ▶ Terminal  
Pillar Terminal
- ▶ Applicable Wire  
1 mm<sup>2</sup> - 4 mm<sup>2</sup>
- ▶ Terminal Capacity  
1.5 mm<sup>2</sup> × 3  
2.5 mm<sup>2</sup> × 2  
4 mm<sup>2</sup> × 1

Intermediate Switch



WBC5014

Technical Specifications الموصفات الفنية

- ▶ Standards  
Comply with BSEN60669-1
- ▶ Rating  
10AX 250V~
- ▶ Ambient Temperature  
-5°C - +40°C
- ▶ Representative Performance  
· Electric strength : 2,000V 1 min  
· Operation test : 40,000 Operations  
· Temperature rise : Test current 13.5A [2.5 mm<sup>2</sup>]  
Not more than 45K (Terminals)
- ▶ Terminal  
Pillar Terminal
- ▶ Applicable Wire  
1 mm<sup>2</sup> - 4 mm<sup>2</sup>
- ▶ Terminal Capacity  
1.5 mm<sup>2</sup> × 3  
2.5 mm<sup>2</sup> × 2  
4 mm<sup>2</sup> × 1

15A Socket



WBC1313

Technical Specifications الموصفات الفنية

- ▶ Standards  
Comply with BS546
- ▶ Rating  
15A 250V~
- ▶ Ambient Temperature  
-5°C - +40°C
- ▶ Representative Performance  
· Electric strength : 1,500V 1 min  
· Operation test : 15,000 times (30,000 movements)  
· Temperature rise : Test current 15A [2.5 mm<sup>2</sup>]  
Not more than 35K (Terminals)
- ▶ Terminal  
Pillar Terminal
- ▶ Applicable Wire  
2.5 mm<sup>2</sup> - 6 mm<sup>2</sup>
- ▶ Terminal Capacity  
2.5 mm<sup>2</sup> × 3  
4 mm<sup>2</sup> × 2  
6 mm<sup>2</sup> × 1

HARMONY BS-TYPE



اخرى  
Others

16A Universal Socket



WBC1510

Technical Specifications الموصفات الفنية

- ▶ Standards  
Comply with IEC60884-1
- ▶ Rating  
16A 250V~
- ▶ Ambient Temperature  
-5°C – +40°C
- ▶ Representative Performance  
·Electric strength  
: 2,000V 1 min  
·Operation test  
: 5,000 times (10,000 movements)  
·Temperature rise  
: Test current 22A (2.5 mm<sup>2</sup>)  
Not more than 45K (Terminals)
- ▶ Terminal  
Pillar Terminal
- ▶ Applicable Wire  
2.5 mm<sup>2</sup> - 6 mm<sup>2</sup>
- ▶ Terminal Capacity  
2.5 mm<sup>2</sup> × 2  
4 mm<sup>2</sup> × 1  
6 mm<sup>2</sup> × 1

German Socket



WBC1610

Technical Specifications الموصفات الفنية

- ▶ Standards  
Comply with IEC60884-1
- ▶ Rating  
16A 250V~
- ▶ Ambient Temperature  
-5°C – +40°C
- ▶ Representative Performance  
·Electric strength  
: 2,000V 1 min  
·Operation test  
: 5,000 times (10,000 movements)  
·Temperature rise  
: Test current 22A (2.5 mm<sup>2</sup>)  
Not more than 45K (Terminals)
- ▶ Terminal  
Pillar Terminal
- ▶ Applicable Wire  
2.5 mm<sup>2</sup> - 6 mm<sup>2</sup>
- ▶ Terminal Capacity  
2.5 mm<sup>2</sup> × 3  
4 mm<sup>2</sup> × 2  
6 mm<sup>2</sup> × 1

Cable Outlet



WBC7010



WBC7020

Technical Specifications الموصفات الفنية

- ▶ Standards and Approvals  
Comply with BS5733
- ▶ Ambient Temperature  
-5°C – +40°C
- ▶ Representative Performance  
·Electric strength  
: 2,000V 1min  
·Temperature rise :  
WBC7010  
: Test current 22A (4 mm<sup>2</sup>)  
WBC7020  
: Test current 49.5A (6 mm<sup>2</sup>)  
Not more than 47K (Terminals)
- ▶ Terminal  
Pillar Terminal
- ▶ Applicable Wire  
WBC7010  
Input : 2.5 mm<sup>2</sup> - 6 mm<sup>2</sup>  
(Rigid Copper Wire)  
Output : 1.5 mm<sup>2</sup> - 2.5 mm<sup>2</sup>  
(Flexible Electrical Wire)  
WBC7020 :  
Input : 4 mm<sup>2</sup> - 16 mm<sup>2</sup>  
(Rigid Copper Wire)  
Output : 4 mm<sup>2</sup> - 16 mm<sup>2</sup>  
(Flexible Electrical Wire)
- ▶ Terminal Capacity  
WBC7010  
: Input 2.5 mm<sup>2</sup>, 4 mm<sup>2</sup>,  
6 mm<sup>2</sup> × 1  
Output 1.5 mm<sup>2</sup>,  
2.5 mm<sup>2</sup>, × 1  
WBC7020  
: Input 4 mm<sup>2</sup>, 6 mm<sup>2</sup>,  
10 mm<sup>2</sup>,  
16 mm<sup>2</sup> × 1  
Output 4 mm<sup>2</sup>, 6 mm<sup>2</sup>,  
10 mm<sup>2</sup>,  
16 mm<sup>2</sup> × 1

Fuse Unit



WBC7100



WBC7101

Technical Specifications الموصفات الفنية

- ▶ Standards  
Comply with BS1363-4
- ▶ Rating  
13A 250V~
- ▶ Ambient Temperature  
-5°C – +40°C
- ▶ Representative Performance  
·Electric strength  
: 2,000V 1 min  
·Temperature rise  
: Test current 20A (2.5 mm<sup>2</sup>)  
Not more than 52K (Terminals)
- ▶ Terminal  
Pillar Terminal
- ▶ Applicable Wire  
2.5 mm<sup>2</sup> - 6 mm<sup>2</sup>
- ▶ Terminal Capacity  
2.5 mm<sup>2</sup> × 3  
4 mm<sup>2</sup> × 2  
6 mm<sup>2</sup> × 1

Shaver Socket



WBC9120

Technical Specifications الموصفات الفنية

- ▶ Standards  
Comply with BSEN61558-2-5
- ▶ Rating  
20VA 250V~
- ▶ Ambient Temperature  
-5°C – +40°C
- ▶ Representative Performance  
·Electric strength  
: 2,000V 1 min  
·Operation test  
: 5,000 times (10,000 movements)  
·Temperature rise  
: Test current 20VA (4 mm<sup>2</sup>)  
Not more than 45K (Terminals)
- ▶ Terminal  
Pillar Terminal
- ▶ Applicable Wire  
2.5 mm<sup>2</sup> - 4 mm<sup>2</sup>
- ▶ Terminal Capacity  
2.5 mm<sup>2</sup> × 1  
4 mm<sup>2</sup> × 1

Switched Multiple Socket Outlet (10A)



WBC1711

Technical Specifications الموصفات الفنية

- ▶ Standards  
Comply with IEC60884-1
- ▶ Rating  
10A 250V~
- ▶ Ambient Temperature  
-5°C – +40°C
- ▶ Representative Performance:  
·Electric strength  
: 2,000V 1 min  
·Operation test  
: 5,000 times  
·Temperature rise  
: Test current 16A (2.5 mm<sup>2</sup>)  
Not more than 45K (Terminals)
- ▶ Terminal  
Pillar Terminal
- ▶ Applicable Wire  
2.5 mm<sup>2</sup> - 6.0 mm<sup>2</sup> /  
14 AWG - 12 AWG
- ▶ Terminal Capacity  
2.5 mm<sup>2</sup> × 3  
4 mm<sup>2</sup> × 2  
6 mm<sup>2</sup> × 1

HARMONY BS-TYPE



اخرى  
Others

13A Socket without Switch

Technical Specifications الموصفات الفنية



WBC1210

- ▶ Standards  
Comply with BS1363-2
- ▶ Rating  
13A 250V~
- ▶ Ambient Temperature  
-5°C - +40°C
- ▶ Representative Performance
  - Electric strength : 2,000V 1 min :
  - Operation test : 15,000 times (30,000 movements)
  - Temperature rise : Test current 20A (2.5 mm<sup>2</sup>)  
Not more than 52K (Terminals)
- ▶ Terminal  
Pillar Terminal
- ▶ Applicable Wire  
1.5 mm<sup>2</sup>- 4 mm<sup>2</sup>  
15 AWG - 12 AWG
- ▶ Terminal Capacity  
1.5 mm<sup>2</sup> × 3  
2.5 mm<sup>2</sup> × 3  
4 mm<sup>2</sup> × 2

SIMPLUS BS-TYPE

SIMPLUS

Switches 10AX مفاتيح كهربائية 10 امبير

Switches 10AX

1Way Switch



WSBC5011W/F

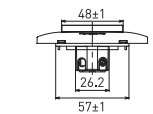
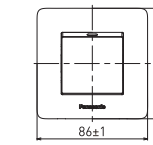

WSBC5021W/F

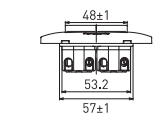
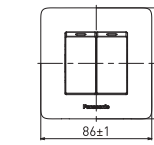

WSBC5031W/F

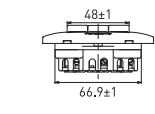
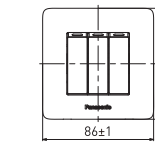

WSBC5091W/F

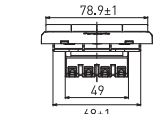
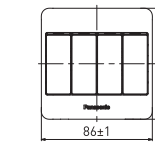

2Way Switch



WSBC5041W/F

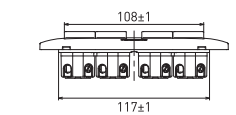
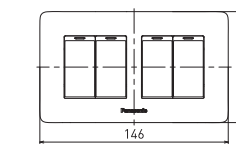

WSBC5012W/F

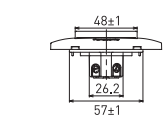
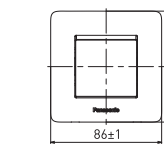

WSBC5022W/F

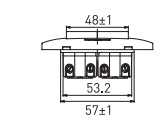
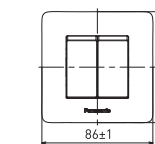

WSBC5032W/F

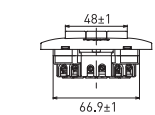
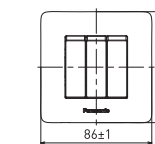

WSBC5092W/F

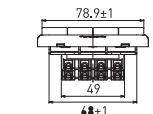
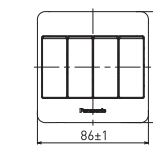

WSBC5042W/F

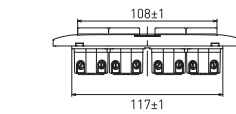
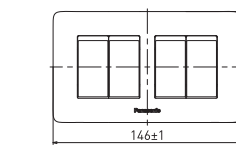

Technical Specifications الموصفات الفنية

- ▶ Standards: Comply with BSEN60669-1
- ▶ Rating: 10AX 250V~
- ▶ Ambient Temperature: -5°C - +40°C
- ▶ Representative Performance:
  - Electric strength : 2,000V 1 min
  - Operation test : 40,000 Operations
  - Temperature rise : Test current 13.5A (2.5 mm<sup>2</sup>)  
Not more than 45K (Terminals)
- ▶ Terminal: Pillar Terminal
- ▶ Applicable Wire: 1 mm<sup>2</sup> - 4 mm<sup>2</sup>
- ▶ Terminal Capacity: 1.5 mm<sup>2</sup> × 3, 2.5 mm<sup>2</sup> × 2, 4 mm<sup>2</sup> × 1\*

\* Not applicable for the WSBC5091 and WSBC5092.