

خطوط نظيفة للتصاميم ذات المظهر الحاد التي تضيف إلى جاذبية غرف المعيشة وكذلك المكاتب

Clean lines for sharp-looking designs that add to the attractiveness of living rooms as well as offices.



FULL-COLOR
WIDE BS-TYPE
SERIES

تصميمات مربعة بسيطة بأناقة ELEGANTLY SIMPLE SQUARE DESIGNS

Add a refreshing accent to any room. Bold, modern plates with square shapes available in various configurations to suit residential and commercial requirements.



أحدث آلية تبديل مقاومة للحرارة وسهلة الاستخدام

HEAT-RESISTANT, EASY-TO-USE LATEST SWITCH MECHANISM

A basic Panasonic wiring device with simple, trouble-free switch mechanism.

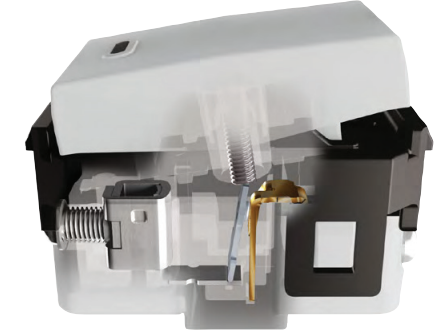

تضمن ميزات الموثوقية عالية السلامة

HIGH RELIABILITY FEATURES ENSURE SAFETY

Complies with requirements of the Saudi Arabian Standards Organization (SASO) & Emirates Quality Mark.

















FULL-COLOR WIDE SERIES BS-TYPE











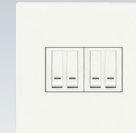

Quick Connect Terminal II
Solid Wire : 1.5-2.5mm²
Stranded Wire : 1.5-2.5mm²

Screw Terminal
Please check applicable wires in technical details.

اكسسورات Switches

<p>WEBP515117 1-Gang 1Way Switch, 16AX 250V with Plate</p>  <p>★</p>	<p>WEBP525217 1-Gang 2-Device 1Way Switch, 16AX 250V with Plate</p>  <p>★</p>	<p>WEBP535317K 1-Gang 3-Device 1Way Switch, 16AX 250V with Plate</p>  <p>★</p>	<p>WEBP515127 1-Gang 2Way Switch, 16AX 250V with Plate</p>  <p>★</p>	<p>WEBP525227 1-Gang 2-Device 2Way Switch, 16AX 250V with Plate</p>  <p>★</p>	<p>WEBP535327K 1-Gang 3-Device 2Way Switch, 16AX 250V with Plate</p>  <p>★</p>	<p>WEBP545227 NEW 1-Gang 4-Device 2Way Switch, 10AX 250V with Plate</p>  <p>★</p>
<p>WNG5001W-791 1Way Switch, 15AX 250V Coming Soon WNG500107W-SA Coming Soon 1Way Switch, 16AX 250V WZB7831WK (Plate) 1-Gang 1-Device</p>  <p>★</p> <p>Combination Model number WNBP5110630F</p>	<p>WNG5001W-791 X 2 1Way Switch, 15AX 250V Coming Soon WNG500107W-SA X 2 Coming Soon 1Way Switch, 16AX 250V WZB7832WK (Plate) 1-Gang 2-Device</p>  <p>★</p> <p>Combination Model number WNBP5120630F</p>	<p>WNG5001W-791 X 3 1Way Switch, 15AX 250V Coming Soon WNG500107W-SA X 3 Coming Soon 1Way Switch, 16AX 250V WZB7833WK (Plate) 1-Gang 3-Device</p>  <p>★</p> <p>Combination Model number WNBP5130630F</p>	<p>WNG5001W-791 X 4 1Way Switch, 15AX 250V Coming Soon WNG500107W-SA X 4 Coming Soon 1Way Switch, 16AX 250V WZB7834WK (Plate) 2-Gang 4-Device</p>  <p>★</p> <p>Combination Model number WNBP5140630F</p>			
<p>WNG5002W-791 2Way Switch, 15AX 250V Coming Soon WNG500207W-SA Coming Soon 2Way Switch, 16AX 250V WZB7831WK (Plate) 1-Gang 1-Device</p>  <p>★</p> <p>Combination Model number WNBP5210630F</p>	<p>WNG5002W-791 X 2 2Way Switch, 15AX 250V Coming Soon WNG500207W-SA X 2 Coming Soon 2Way Switch, 16AX 250V WZB7832WK (Plate) 1-Gang 2-Device</p>  <p>★</p> <p>Combination Model number WNBP5220630F</p>	<p>WNG5002W-791 X 3 2Way Switch, 15AX 250V Coming Soon WNG500207W-SA X 3 Coming Soon 2Way Switch, 16AX 250V WZB7833WK (Plate) 1-Gang 3-Device</p>  <p>★</p> <p>Combination Model number WNBP5230630F</p>	<p>WNG5002W-791 X 4 2Way Switch, 15AX 250V Coming Soon WNG500207W-SA X 4 Coming Soon 2Way Switch, 16AX 250V WZB7834WK (Plate) 2-Gang 4-Device</p>  <p>★</p> <p>Combination Model number WNBP5240630F</p>			

<p>WNG5021W-7 1Way Twin Switch, 10AX 250V WZB7831WK (Plate) 1-Gang 1-Device</p>  <p>★</p> <p>Combination Model number WNBP5101610F</p> <p style="text-align: center;">*Stock Only</p>	<p>WNG5021W-7 X 2 1Way Twin Switch, 10AX 250V WZB7832WK (Plate) 1-Gang 2-Device</p>  <p>★</p> <p>Combination Model number WNBP5141610F</p> <p style="text-align: center;">*Stock Only</p>	<p>WNG5021W-7 X 4 1Way Twin Switch, 10AX 250V WZB7834WK (Plate) 2-Gang 4-Device</p>  <p>★</p> <p>Combination Model number WNBP5181610F</p> <p style="text-align: center;">*Stock Only</p>	
<p>WEG5534 Intermediate Switch, 4Way, 16AX 250V WEB7811W (Plate) 1-Gang 1-Device</p>  <p>★</p> <p>Combination Model number WEBP5513630F</p>	<p>WEG5401-7-P Push Button, 10A 250V WEB7811W (Plate) 1-Gang 1-Device</p>  <p>★</p> <p>Combination Model number WEBP5113650F</p>	<p>WNG5401-7K-P Appellation Push Button "B" SP 10A 250V WZB7831WK (Plate) 1-Gang 1-Device</p>  <p>★</p> <p>Combination Model number WNBP5113660F</p>	<p>WNG5401-7K-P X 2 Appellation Push Button "B" SP 10A 250V WZB7832WK (Plate) 1-Gang 2-Device</p>  <p>★</p> <p>Combination Model number WNBP5123660F</p>
<p>WEG553272 20A 2Way SP Switch WEB7811W (Plate) 1-Gang 1-Device</p>  <p>★</p> <p>Combination Model number WEBP5214730F</p>	<p>WEG55337 20A DP Switch with Indicator WEB7811W (Plate) 1-Gang 1-Device</p>  <p>★</p> <p>Combination Model number WEBP5414600F</p>	<p>WEG55337-SP 20A DP Switch with Water Heater Mark WEB7811 (Plate) 1-Gang 1-Device</p>  <p>★</p> <p>Combination Model number WEBP5414630F</p>	<p>WEBP52832 Shutter Switch with Plate</p>  <p>★</p>
<p>WNBP5428690FK 45A DP Switch with Indicator and 1-Gang Plate, Pillar Terminal</p>  <p>★</p> <p>WNBP5428690F (old model) WBG5408699W 45A DP Switch with Indicator WZB7832WK-1 (Plate) 1-Gang 2-Device</p>			

FLATIMA SERIES
BS-TYPE

FULL-COLOR WIDE SERIES
Refina BS-TYPE

FULL-COLOR WIDE SERIES
BS-TYPE

FULL-COLOR SERIES
BS-TYPE

FLATIMA SERIES
BS-TYPE

FULL-COLOR WIDE SERIES
Refina BS-TYPE

FULL-COLOR WIDE SERIES
BS-TYPE

FULL-COLOR SERIES
BS-TYPE

FULL-COLOR WIDE SERIES BS-TYPE

★ Screw Terminal
Please check applicable wires
in technical details.

مقابس
Socket Outlets

WNBP5448690FK
45A DP Switch with Indicator and 2-Gang Plate, Pillar Terminal



★

WNBPS448690F (old model)
WBG5408699W
45A DP Switch with Indicator
WZB7817W (Plate)
2-Gang 2-Device

WEBP13117W NEW
13A 250V 1-Gang Unswitched Socket Outlet with Plate



★

WEB11119W
13A 250V 1-Gang DP Switched Socket Outlet with Plate

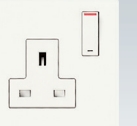

★

WEB1111WK (old model)
13A 250V 1-Gang DP Switched Socket Outlet with Plate

WEB11129W
13A 250V 2-Gang DP Switched Socket Outlet with Plate



★

WEB1112WK (old model)
13A 250V 2-Gang DP Switched Socket Outlet with Plate

WEG10817
16A 250V Universal Socket with Shutter

WEG55317
1Way Switch 16AX 250V
WEB7812W (Plate)
1-Gang 2-Device



★

Combination Model number
WEBP5120632F

WEG10817
16A 250V Universal Socket with Shutter

WEG55317 X 2
1Way Switch 16AX 250V
WEB7813W (Plate)
1-Gang 3-Device



★

Combination Model number
WEBP5130632F

WEG15827
16A 250V Grounding Universal Socket with Shutter

WEB7813W (Plate)
1-Gang 3-Device



★

Combination Model number
WEBP1824710F

WEG11817
16A 250V Universal Multi Socket with Shutter

WEB7812W (Plate)
1-Gang 2-Device



★

Combination Model number
WEBP1814710F

اكسسورات
Accessories

WEB11114 NEW
13A 250V Socket Outlet 1-Gang, DP Switched Socket Outlet with 1 port USB Charger



★

WEB1131WK
15A 250V 1-Gang Switched Round Pin Outlet with Plate

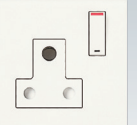

★

WEG11517
3Wire Grounding Socket Outlet 15A 127V
WEB7812W (Plate)
1-Gang 2-Device



★

Combination Model number
WEBP1619610F

WNG1101W-791
15A 127V 3Wire Grounding Socket
WZB7831WK (Plate)
1-Gang 1-Device



★

Combination Model number
WNBP1619600F

WEG2364
Telephone Socket 6P4C
WEB7811W (Plate)
1-Gang 1-Device



★

Combination Model number
WEBP4519940F

WEG2364 X 2
Telephone Socket 6P4C
WEB7812W (Plate)
1-Gang 2-Device



★

Combination Model number
WEBP4529940F

WEG2501-P
TV Socket DIN Type
WEB7811W (Plate)
1-Gang 1-Device



★

Combination Model number
WEBP4719830F

WEG2501-P X 2
TV Socket DIN Type
WEB7812W (Plate)
1-Gang 2-Device



★

Combination Model number
WEBP4729830F

WNG1101W-791 X 2
15A 127V 3Wire Grounding Socket
WZB78322W (Plate)
1-Gang 2-Device



★

Combination Model number
WNBP1629630F

WEG10817
16A 250V Universal Socket with Shutter
WEB7811W (Plate)
1-Gang 1-Device



★

Combination Model number
WEBP1914610F

WEG10817 X 2
16A 250V Universal Socket with Shutter
WEB7812W (Plate)
1-Gang 2-Device



★

Combination Model number
WEBP1924610F

WEG10817 X 3
16A 250V Universal Socket with Shutter
WEB7813W (Plate)
1-Gang 3-Device



★

Combination Model number
WEBP1934610F

WEG2731
TV Socket F Type
WEB7811W (Plate)
1-Gang 1-Device



★

Combination Model number
WEBP47194501F

WEG2741 NEW
TV Socket F Type
WEB7811W (Plate)
1-Gang 1-Device



★

Combination Model number
WEBP47164501F

WEG2731 X 2
TV Socket F Type
WEB7812W (Plate)
1-Gang 2-Device



★

Combination Model number
WEBP47294501F

WEG2364
Telephone Socket 6P4C
WEG2501-P
TV Socket DIN Type
WEB7812W (Plate)
1-Gang 2-Device



★

Combination Model number
WEBP4529942F

*Stock Only

*Stock Only

*Stock Only

WEB111169W
Cooker Control Unit with Plate



★

WEB11116W (old model)
Cooker Control Unit

WEB1741W
13A 250V Socket Outlet Residual Current Device with Plate



★

WEB1741W (old model)
Socket Outlet Residual Current Device with Plate (White)

WEB111159W
13A 250V Socket Outlet 1-Gang, DP Switched with 2-port USB Charger



★

WEB11115W (old model)
Socket Outlet 1-Gang, DP Switched with 2-port USB Charger

FLATIMA SERIES
BS-TYPE

FULL-COLOR WIDE SERIES
Refina BS-TYPE

FULL-COLOR WIDE SERIES
BS-TYPE

FULL-COLOR SERIES
BS-TYPE

FLATIMA SERIES
BS-TYPE

FULL-COLOR WIDE SERIES
Refina BS-TYPE

FULL-COLOR WIDE SERIES
BS-TYPE

FULL-COLOR SERIES
BS-TYPE

FULL-COLOR WIDE SERIES BS-TYPE



<p>WEG2364 Telephone Socket 6P4C WE2731-8 TV Socket F Type WEB7812W (Plate) 1-Gang 2-Device</p> <p>Combination Model number WEBP45299471F</p>	<p>WEG2488-P Cat 5E Outlet WEB7811W (Plate) 1-Gang 1-Device</p> <p>Combination Model number WEBP4519980F</p>	<p>WEG2488-P X 2 Cat 5E Outlet WEB7812W (Plate) 1-Gang 2-Device</p> <p>Combination Model number WEBP4529980F</p>	<p>WEG24886-P Cat 6 Outlet WEB7811W (Plate) 1-Gang 1-Device</p> <p>Combination Model number WEBP4519680F</p>
---	---	---	---

USB Charger شاحن USB

<p>WNF1071W8 1-port USB Charger, white WZB7832WK (Plate) 1-Gang 2-Device</p> <p>Combination Model number WNBP1426120DF</p>	<p>WNF1072W8 2-port USB Charger, white WZB7832WK (Plate) 1-Gang 2-Device</p> <p>Combination Model number WNBP1072F</p>
---	---

WNBP1072DF-1
WNF1072W8-1
Vertical Type

<p>WEG24886-P X 2 Cat 6 Outlet WEB7812W (Plate) 1-Gang 2-Device</p> <p>Combination Model number WEBP4529680F</p>	<p>WEG2364 Telephone Socket 6P4C WE24886-P TV Socket F Type WEB7812W (Plate) 1-Gang 2-Device</p> <p>Combination Model number WEBP4529682F</p>	<p>WEB7010W NEW 1-Gang Cable Outlet with 20A Terminal Block</p>	<p>WEB7020W NEW 1-Gang Cable Outlet with 45A Terminal Block</p>
---	---	---	---

<p>WEF1172W8K 2-port USB Charger, white WEB7812W (Plate) 1-Gang 2-Device</p> <p>Combination Model number WEBP1172F</p>	<p>WEBP11721F WEF11721W8K Vertical Type</p>
---	--

ديمر لتحديد شدة الاضاءة
Dimmer Switches

<p>WEG578153 Dimmer Switch 500W 220-240V~ 50/60Hz WEB7812W (Plate) 1-Gang 2-Device</p> <p>Combination Model number WEBP5781530F</p>	<p>WEG57912-P LED Dimmer Switch 200W (LED50W) 220-240V~ 50/60Hz WEB7812W (Plate) 1-Gang 2-Device</p> <p>Combination Model number WEBP579120F</p>	<p>WEG57915-P NEW LED Dimmer Switch 240W(LED200W) 220-240V~ 50/60Hz WEB7812W (Plate) 1-Gang 2-Device</p> <p>Combination Model number WEBP579150F</p>
--	---	--

المقبس HDMI
HDMI Connector

<p>WEG2021 NEW Connector for HDMI Connection WEB7811W (Plate) 1-Gang 1-Device</p> <p>Combination Model number WEBP42150F</p>
--

FLATIMA SERIES
BS-TYPE

FULL-COLOR WIDE SERIES
Refina BS-TYPE

FULL-COLOR WIDE SERIES
BS-TYPE

FULL-COLOR SERIES
BS-TYPE

FLATIMA SERIES
BS-TYPE

FULL-COLOR WIDE SERIES
Refina BS-TYPE

FULL-COLOR WIDE SERIES
BS-TYPE

FULL-COLOR SERIES
BS-TYPE

FULL-COLOR WIDE SERIES BS-TYPE , A-TYPE
 FULL-COLOR WIDE SERIES Refina BS-TYPE , A-TYPE
 مفاتيح كهربائية 16 امبير
Switches 16AX

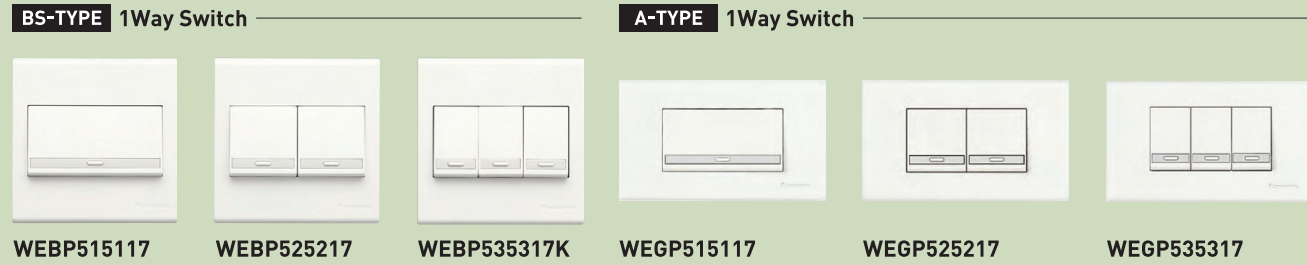

Technical Specifications الموصفات الفنية

- ▶ Standards
Comply with IEC60669-1
- ▶ Rating
16AX 250V~
- ▶ Ambient Temperature
-10°C ~ +40°C
- ▶ Representative Performance
 - Electric strength : 2,000V 1 min
 - Operation test : 40,000 Operations
 - Temperature rise : Test current 20A (2.5 mm²)
Not more than 45K (Terminals)
- ▶ Terminal
Pillar Terminal II
- ▶ Applicable Wire
1.5 mm² - 4 mm²
15 AWG - 12 AWG
- ▶ Terminal Capacity
1.5 mm² × 3
2.5 mm² × 2
4 mm² × 1

Features المميزات

Improved contact reliability through our design using proprietary technology.

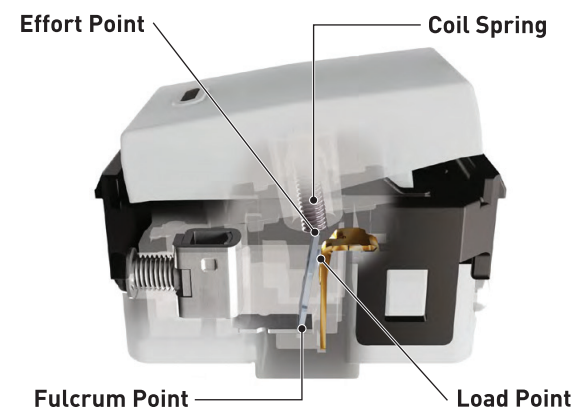

Coil Spring Reversal Method

Panasonic's proprietary coil spring reversal method, causes the pressure applied on the connector to be stable, so that it does not become very hot. By keeping the bound small, the production of arc energy is minimized.

- Because the damage is small, the contacts do not fuse easily, making them long lasting.
- Our products have cleared the On/Off testing for 40,000 operations required by IEC.

Urea Resin

The use of urea resin which is safer and more secure has led to improved fire resistance. It also has excellent tracking resistance which prevents electric shocks.

- Even when the product is wrongly used, the casing does not fuse. As such, it is fire proof and shock proof.
- It is resistant to fire caused by tracking on the surface of the socket, and the material itself does not melt easily.
- Since the material is highly insulated so that electricity does not pass through it, it is shock proof.

Pillar Terminal

- Built-in pillar terminal accommodates any wire configuration.
- 1 mm² - 4 mm²

Features المميزات

Urea Resin

Characteristics of Urea Resin

- Excellent arc resistance, arc tracking resistance, flame retardance, heat resistance, color fastness.
- Has good electrical performance and mechanical strength with excellent abrasion resistance.
- Difficult to scratch, and there is virtually no adherence of dust due to static electricity.
- Organic solvents and oily substances cannot permeate.

Enclosure Material Characteristics (reference)

	Urea	PBT	Polycarbonate
Tracking Performance	Excellent	Good	Poor
Heat Deformation	Good	Good	Fair
Self-Extinguishment	Good	Good	Good

Coil Spring Reversal Method

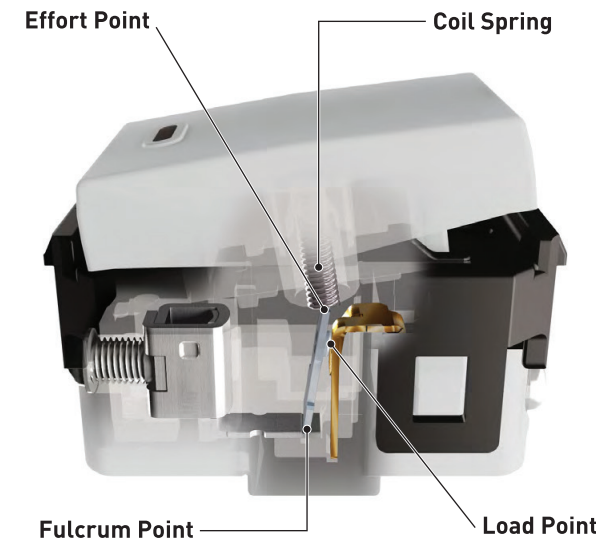

Bounce Performance Comparison

The Full-Color Series has a coil spring system to reduce arc energy generation, making it ideal for compact fluorescent lighting (CFL), inverter illumination and LED lighting.

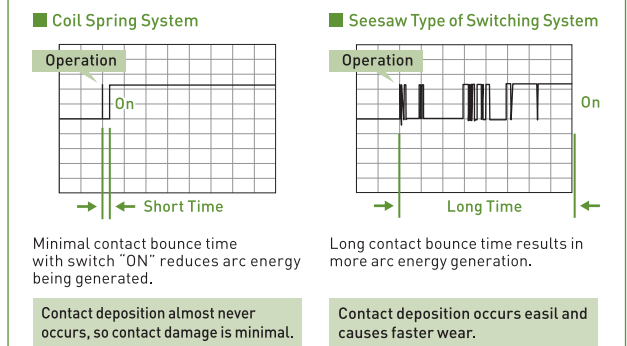

Terminal

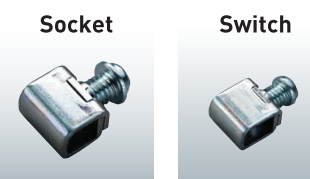

Flexible wire (class 5) also applicable

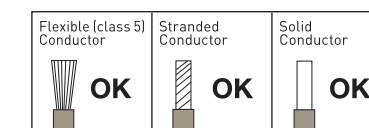

Rigid (Solid or Stranded) & Flexible (only class 5) Copper Conductor Type

TECHNICAL DETAILS تفاصيل تقنية

Dimensions الأبعاد

BS-TYPE 1Way Switch

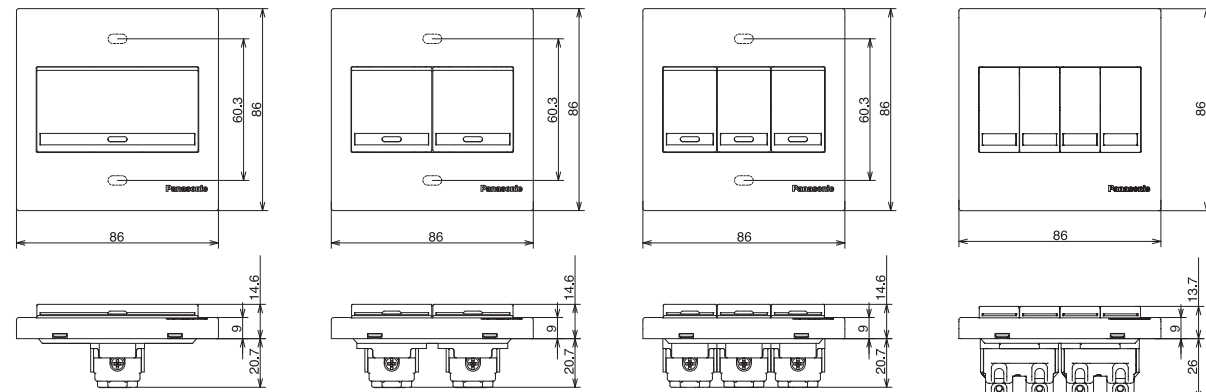

WEBP515117

WEBP525217

WEBP535317K

WEBP545227

*BS-TYPE : with screws for insert.

➔ See Page 106 for detail spec

A-TYPE 1Way Switch

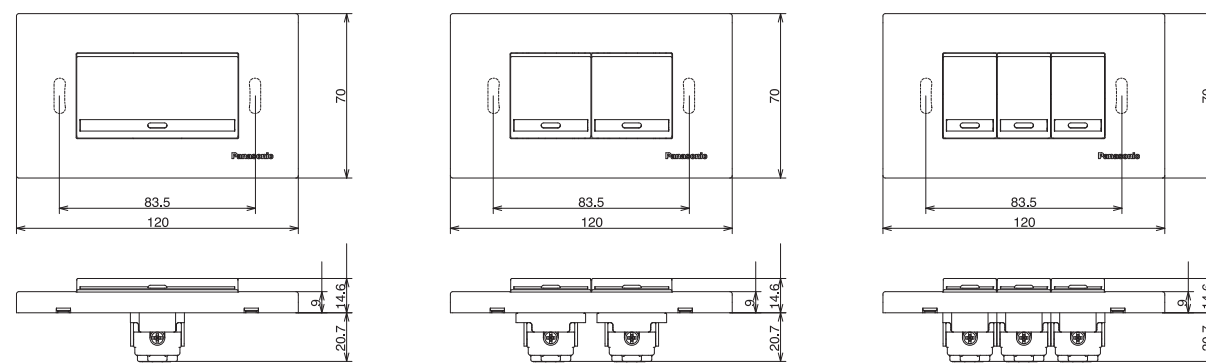

WEGP515117

WEGP525217

WEGP535317

Applicable Box صندوق قابل للتطبيق

BS-TYPE



► Dimensions
Plate : 86 x 86 mm
Box : 72 x 72 mm
Fixing Center : 60.3 mm



► Dimensions
Plate : 86 x 146 mm
Box : 72 x 132 mm
Fixing Center : 120.6 mm

A-TYPE

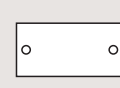

► Dimensions
Plate : 70 x 120 mm
Box : 51 x 102 mm
Fixing Center : 83.5 mm

FULL-COLOR WIDE SERIES BS-TYPE , A-TYPE FULL-COLOR WIDE SERIES Refina BS-TYPE , A-TYPE مفاتيح كهربائية 20 أمبير Switches 20A



BS-TYPE DP Switch with Indicator



WEG55337
WEB7811W
WEGP5414600F

A-TYPE DP Switch with Indicator



WEG55337
WEG6801WK-P
WEGP5414600F

Technical Specifications الموصفات الفنية

- Standards
Comply with IEC60669-1
- Rating
20A 250V~
- Ambient Temperature
-10°C – +40°C
- Representative Performance
 - Electric strength : 2,000V 1 min
 - Operation test : 10,000 Operations
 - Temperature rise : Test current 25A (4 mm²)
Not more than 45K (Terminals)
- Terminal
Pillar Terminal II
- Applicable Wire
2.5 mm² - 6 mm²
13 AWG - 10 AWG
- Terminal Capacity
2.5 mm² × 2
4 mm² × 1
6 mm² × 1

Features المميزات

- Switching mechanism uses a coil spring system for a longer service life.
- Made with flame-retardant and heat-resistant urea resin.
- Conductive section uses heat-resistant copper with superior anticorrosion property and conductivity for long-term stable, reliable performance.
- Accepts wires : 2.5 mm² - 6 mm² solid wire to flexible wire (class 5).

Dimensions الأبعاد

BS-TYPE DP Switch with Indicator

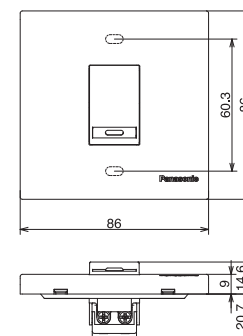

A-TYPE DP Switch with Indicator

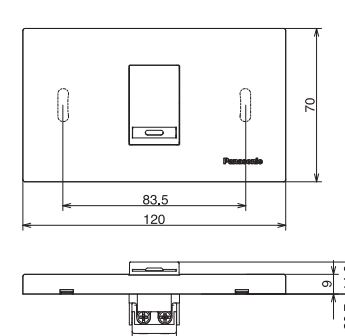

*BS-TYPE : M3.5 mounting screws included.

FULL-COLOR WIDE SERIES BS-TYPE, A-TYPE
 FULL-COLOR WIDE SERIES Refina BS-TYPE, A-TYPE
 مفاتيح كهربائية 45A
Switches 45A



BS-TYPE DP Switch with Indicator

OLD MODEL
WBG5408699W
WZB7832WK -1
 WNB5428690F
 NEW MODEL
WNB5428690FK



OLD MODEL
WBG5408699W
WZB7817W
 WNB5448690F
 NEW MODEL
WNB5448690FK

A-TYPE DP Switch with Indicator

OLD MODEL
WBG5408699W
WN3020W-P, WZB7843W
 WNGP5438693F
 NEW MODEL
WNGP5438693FK



FULL-COLOR WIDE SERIES BS-TYPE, A-TYPE
 FULL-COLOR WIDE SERIES Refina BS-TYPE, A-TYPE
 ديمر لتحديد شدة الاضاءة
Dimmer Switches



BS-TYPE 500W (Low Voltage)

WEG578153
WEB7812W
 WEBP5781530F



BS-TYPE LED Dimmer

WEG57912-P
WEB7812W
 WEBP579120F



WEG57915-P
WEB7812W
 WEBP579150F

Technical Specifications الموصفات الفنية

- Standards
Comply BS EN 60669-1
- Rating
45A 250V ~ (Resistive)
Motor Full load current of 25A or less, power factor of 0.8 or more
- Ambient Temperature
-10°C – +40°C
- Representative Performance
·Electric strength : 1,500V 1 min
·Operation test : 10,000 operations
·Temperature rise : Test current 51A (16 mm²)
Not more than 45K (Terminals)
- Terminal
Pillar Terminal
- Applicable Wire
[Solid] 4 mm²
[Stranded] 4 mm² - 16 mm²
[AWG] AWG 10 - AWG 6
- Terminal Capacity
4 mm² × 2
6 mm² × 2
10 mm² × 1
16 mm² × 1

Features المميزات

- High -capacity silver contact for longer life.
- Made with flame-retardant and heat-resistant melamine phenol/urea resins.
- Conductive section uses heat-resistant copper with superior anticorrosion property and conductivity for long-term stable, reliable performance.
- Built-in lighted indicator shows On/Off status.
- Normal gap double-pole switch (minimum contact gap : 3 mm) construction ensures safe load shut-off.
- Double Earth Terminal.

Dimensions الأبعاد

BS-TYPE DP Switch with Indicator

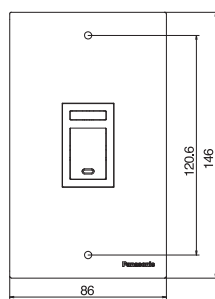
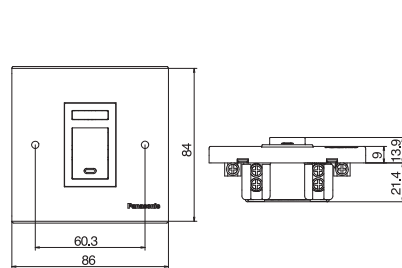

A-TYPE DP Switch with Indicator

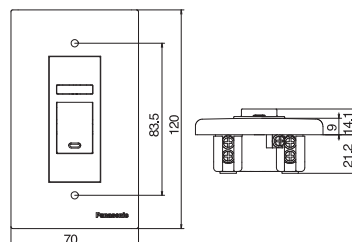

*BS-TYPE : M3.5 mounting screws included.

WEG578153

- Rating : 220V-240V~ 500W
- Ambient Temperature : 0°C – +35°C
- Terminal : Screw Terminal
- Applicable Wire : 1 mm²- 2.5 mm²

WEBP579120F / WEBP579150F

- Rating : 220V-240V- 50/60Hz
- LED 50W(WEBP579120F)
- LED200W(WEBP5709150F)
- Ambient Temperature:0°C - 35°C
- Terminal : Pillar (WEBP579120F)
Screw(WEBP579150F)
- Applicable Wire: 1mm²- 2.5mm²(WEBP579120F)
1mm²- 4mm²(WEBP579150F)

Features المميزات

WEG578153

- Applicable Wires : 1 mm² - 2.5 mm²
- Compatible with 500VA copper/steel and step-down transformers.
- Applicable for low-voltage halogen lamp use.
- Applicable for 500W incandescent lamp.

WEBP579120F / WEBP579150F

Applicable incandescent lamps & low voltage halogen lamps & LED bulbs

- Chandelier lamp
- Silica lamp
- Clear lamp
- Hi-beam lamp

- Halogen lamp
- LED dimmable bulb

- When using low voltage halogen lamps, requires an applicable transformer to convert voltage from 220 V - 240 V to 12 V.
- The brightness when dimmed is different depending on the LED bulb types and Brand.
- When the knob is lower limit, brightness is different depending on the LED bulb types and Brand.
- Be sure to use a light bulb with a built-in fuse. Not doing so may result in damage to the dimmer switch when the light bulb burns out.

*Those products can't operate ventilating / ceiling fan.

Dimensions الأبعاد

BS-TYPE 500W (Low Voltage)

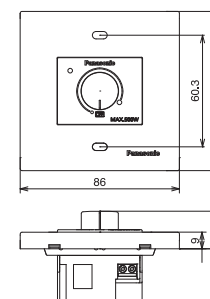

BS-TYPE LED Dimmer

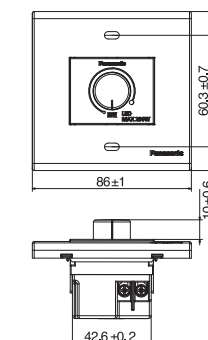
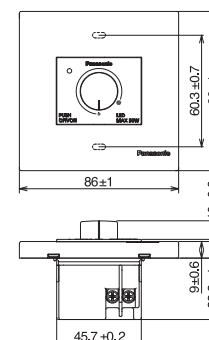

*BS-TYPE : M3.5 mounting screws included.

FULL-COLOR WIDE SERIES BS-TYPE
FULL-COLOR WIDE SERIES Refina BS-TYPE
مقابس
Socket Outlets



BS-TYPE Switched Socket

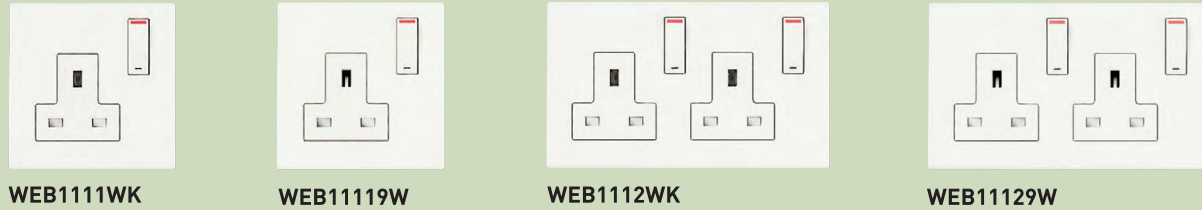

FULL-COLOR WIDE SERIES BS-TYPE, A-TYPE
FULL-COLOR WIDE SERIES Refina BS-TYPE, A-TYPE
اكسسوارات
Accessories - Television

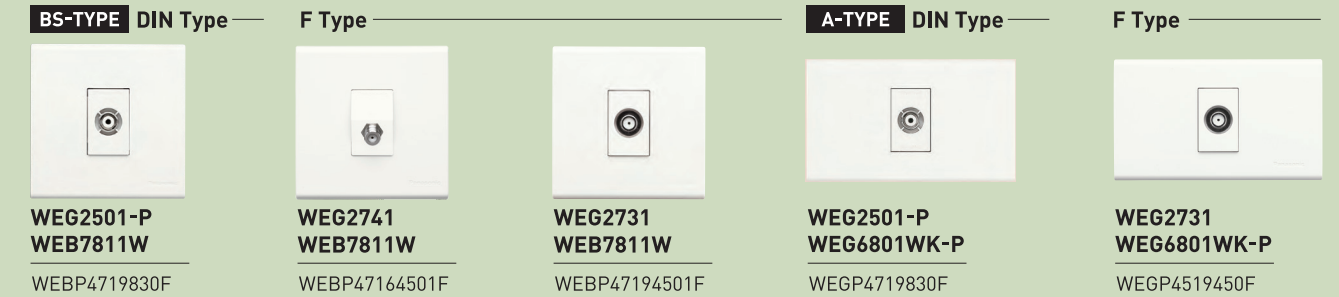

Technical Specifications الموصفات الفنية

- Standards: Comply with BS1363-2 and IEC60884-1
- Rating: 13A 250V~
- Ambient Temperature: -10°C – +40°C
- Representative Performance:
 - Electric strength : 2,000V 1 min
 - Operation test : 15,000 times (30,000 movements)
 - Temperature rise : Test current 20A (2.5 mm²) Not more than 52K (Terminals)
- Terminal: Pillar Terminal II
- Applicable Wire: 1.5 mm² - 4 mm²
- Terminal Capacity:
 - 1.5 mm² × 3
 - 2.5 mm² × 3
 - 4 mm² × 2

Features المميزات

- Socket Outlet with a double-pole switch completely isolates load from power supply.
- Socket Outlet housing uses flame-retardant and heat-resistant urea resin with high anti-tracking properties.
- Accepts wires : 1.5 mm² - 4 mm² solid wire to flexible wire.
- Both socket and switch parts made for enough switching capability.
- Included safety shutter prevents kids from tampering with switch.

Dimensions الأبعاد

BS-TYPE Switched Socket

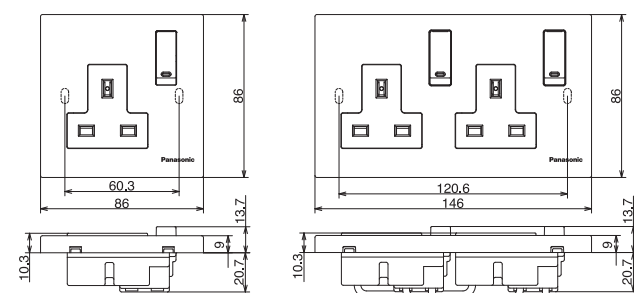

Applicable Box صندوق قابل للتطبيق

BS-TYPE

- Dimensions:
 - Plate : 86 x 86 mm
 - Box : 72 x 72 mm
 - Fixing Center : 60.3 mm
- Dimensions:
 - Plate : 86 x 146 mm
 - Box : 72 x 132 mm
 - Fixing Center : 120.6 mm

*BS-TYPE : M3.5 mounting screws included.

Technical Specifications الموصفات الفنية

- Connector Type (Outlet) : DIN Type
- Terminal: Screw Terminal (Only coaxial core isn't screw terminal type)
- Impedance Input, Outlet : 75Ω
- Applicable Cable: Coaxial Cable Characteristic Impedance 75Ω type : 5C - 2V, 3C - 2V
- Connector Type (Outlet): F type
- Terminal: Screw Terminal (Only coaxial core isn't screw terminal type)
- Impedance Input, Outlet : 75Ω
- Applicable Cable: Coaxial Cable Characteristic Impedance 75Ω type : S-5C-FB

Features المميزات

“Easy Connect” terminal for direct insertion of coaxial cable core.
Insert fully and tighten clamp.

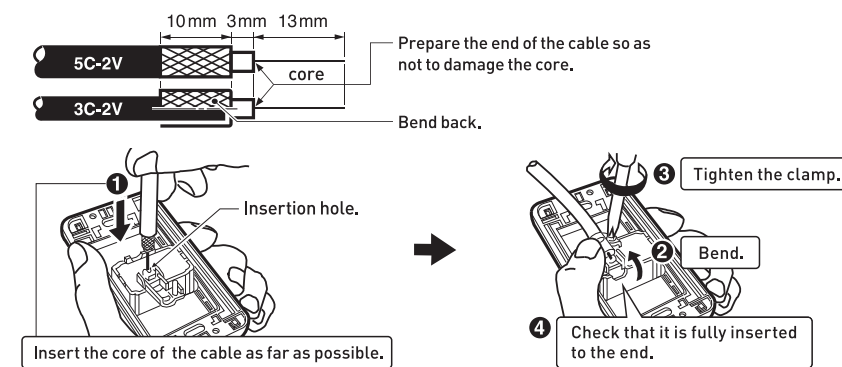

Dimensions الأبعاد

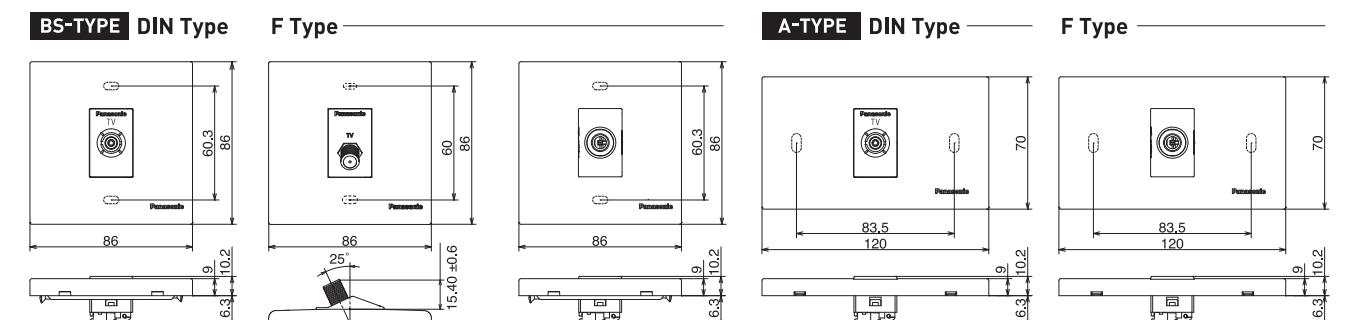

*BS-TYPE : M3.5 mounting screws included.

FULL-COLOR WIDE SERIES BS-TYPE , A-TYPE
 FULL-COLOR WIDE SERIES Refina BS-TYPE , A-TYPE
 اكسسورات هاتف
Accessories - Telephone



BS-TYPE 6P4C		A-TYPE 6P4C	
WEG2364 WEB7811W WEBP4519940F	WEG2364 WEB7812W WEBP4529940F	WEG2364 WEG6801WK-P WEGP4519940F	WEG2364 WEG6802WK-P WEGP4529940F

FULL-COLOR WIDE SERIES BS-TYPE , A-TYPE
 FULL-COLOR WIDE SERIES Refina BS-TYPE , A-TYPE
 اكسسورات انترنت
Accessories - LAN



BS-TYPE Category 5e , Category 6		A-TYPE Category 5e Category 6		
WEG2488-P WEB7811W WEBP4519980F	WEG24886-P WEB7811W WEBP4519680F	WEG2488-P WEG6801WK-P WEGP4519980F	WEG24886-P WEG6801WK-P WEGP4519680F	WEG24886-P WEG6802WK-P WEGP4529680F

Technical Specifications الموصفات الفنية

- ▶ Connector Type
Miniature Modular Jack, 6 position with 4-contacts, specified in TIA-1096-A (Previously in FCC part 68)
- ▶ Terminal
Quick Connect Terminal (Screwless Connection)
- ▶ Applicable Wire
Paired quad-type PVC indoor cable : Core wire to be 0.4 mm, 0.5 mm, 0.65 mm, in diameter (solid copper only)
2-pair Business-phone indoor cable : Core wire to be 0.4 mm, 0.5 mm, 0.65 mm, in diameter (solid copper only)

Features المميزات

- Quick Connect Terminal increases connection reliability.
- Quick Connect Terminal for easy connection.
- Simple Connection
Just insert cable into the terminal hole.
- Easy Cable Disconnection
Push removal button while pulling out cable.

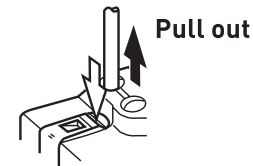
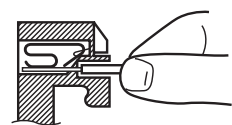

Dimensions الأبعاد

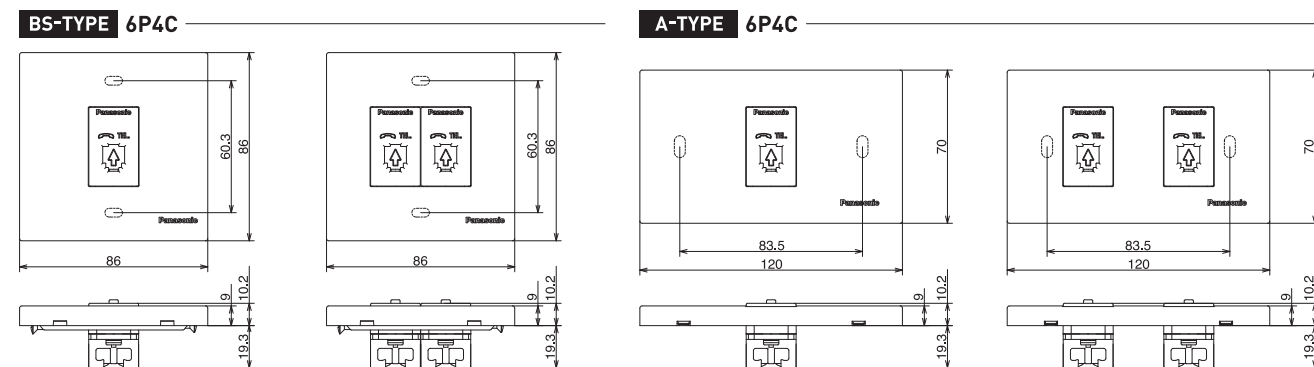

*BS-TYPE : M3.5 mounting screws included.

Technical Specifications الموصفات الفنية

- ▶ Connector Type
"8-way unshielded fixed connector (miniature 8-position modular jack)" specified in IEC 60603-7
- ▶ Terminal
IDC connection
- ▶ Applicable Cable
WEG2488 : 4-pair UTP cable, Category 5e
Conductor : solid copper wire, 24 AWG - 22 AWG (diameter : 0.5 mm-0.65 mm)
or stranded copper wire, 24 AWG
WEG24886 : 4-pair UTP cable, Category 6
Conductor : solid copper wire, 24 AWG - 22 AWG (diameter : 0.5 mm-0.65 mm)

Features المميزات

1 It's not necessary to use special wiring tool. **2 No need to untwist the wires.**

2-way connection

Toolless

Point! Click!

Cut the excess wires with nippers after connection

Using wiring tool

Wiring tool (D.Impact tool)

Excess wires can be cut with the blade edge of the tool

Projection between the slots
No need to untwist the wires to setting on the slots. Minimum untwisting retains uniform installation quality and transmission performance.

Pin/Pair assignment

T568A		T568B (Optional)	
Pair 2	Pair 3	Pair 1	Pair 4
Pair 3	Pair 1	Pair 2	Pair 4
1	2	3	4
5	6	7	8

Pair	Color	Pin No.	
		T568A	T568B
1	W/BL	5	5
	BL	4	4
2	W/O	3	1
	O	6	2
3	W/G	1	3
	G	2	4
4	W/BR	7	7
	BR	8	8

Dimensions الأبعاد

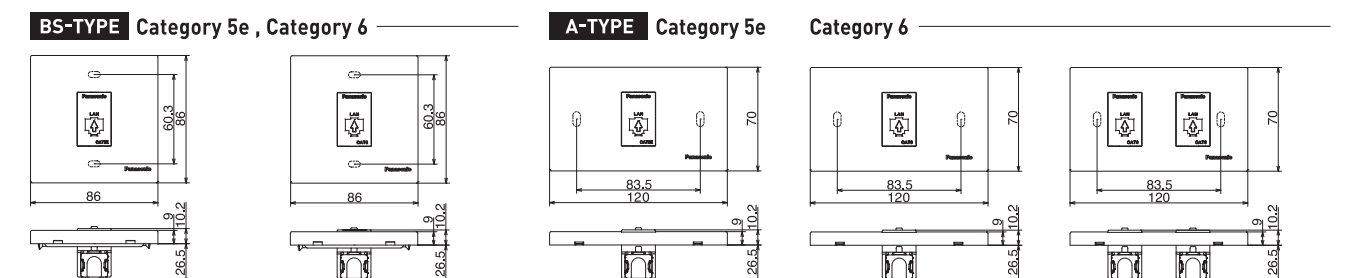

*BS-TYPE : M3.5 mounting screws included.

FULL-COLOR WIDE SERIES BS-TYPE , A-TYPE
 FULL-COLOR WIDE SERIES Refina BS-TYPE , A-TYPE
 اُخري
Others



4G Switch



WEBP545227

Technical Specifications الموصفات الفنية

- | | |
|---|---|
| <ul style="list-style-type: none"> ▶ Standards
Comply with IEC60669-1 ▶ Rating
10AX 250V~ ▶ Ambient Temperature
-10°C – +40°C ▶ Representative Performance <ul style="list-style-type: none"> ·Electric strength
: 2,000V 1 min ·Operation test
: 40,000 Operations ·Temperature rise
: Test current 20A (2.5 mm²)
Not more than 45K (Terminals) | <ul style="list-style-type: none"> ▶ Terminal
Screw Terminal ▶ Applicable Wire
1.0 mm² - 2.5 mm² ▶ Terminal Capacity
1.5 mm² × 1
3.5 mm² × 1
14 AWG × 1
12 AWG × 1 |
|---|---|

Push Button



WEBP5113650F

Technical Specifications الموصفات الفنية

- | | |
|---|--|
| <ul style="list-style-type: none"> ▶ Standards
Comply with IEC60669-1 ▶ Rating
10A 250V ~ ▶ Ambient Temperature
-10°C – +40°C ▶ Representative Performance <ul style="list-style-type: none"> ·Electric strength
: 2,000V 1 min ·Operation test
: 40,000 Operations ·Temperature rise
: Test current 13.5A (2.5 mm²)
Not more than 45K (Terminals) | <ul style="list-style-type: none"> ▶ Terminal
Screw Terminal ▶ Applicable Wire
1 mm² - 2.5 mm² ▶ Terminal Capacity
1 mm² × 1
1.5 mm² × 1
2.5 mm² × 1 |
|---|--|
- *Supply terminal has 2 terminal holes.

Universal Socket



WEBP1914610F

Technical Specifications الموصفات الفنية

- | | |
|---|--|
| <ul style="list-style-type: none"> ▶ Standards
Comply with IEC60884-1 ▶ Rating
16A 250V~ ▶ Ambient Temperature
-10°C – +40°C ▶ Representative Performance <ul style="list-style-type: none"> ·Electric strength
: 2,000V 1 min ·Operation test
: 5,000 times (10,000 movements) ·Temperature rise
: Test current 22A (2.5 mm²)
Not more than 45K (Terminals) | <ul style="list-style-type: none"> ▶ Terminal
Screw Terminal ▶ Applicable Wire
1.5 mm² - 4 mm²
15 AWG - 12 AWG ▶ Terminal Capacity
1.5 mm² × 3
2.5 mm² × 3
4 mm² × 2 |
|---|--|

15A 3Pin Socket

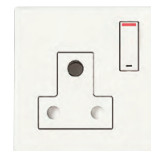

WEB1131WK

Technical Specifications الموصفات الفنية

- | | |
|---|--|
| <ul style="list-style-type: none"> ▶ Standards
Comply with BS546 ▶ Rating
15A 250V~ ▶ Ambient Temperature
-10°C – +40°C ▶ Representative Performance <ul style="list-style-type: none"> ·Electric strength
: 1,500V 1 min ·Operation test
: 15,000 times (30,000 movements) ·Temperature rise
: Test current 15A (2.5 mm²)
Not more than 35K (Terminals) | <ul style="list-style-type: none"> ▶ Terminal
Screw Terminal ▶ Applicable Wire
2.5 mm² - 4 mm² ▶ Terminal Capacity
1.5 mm² × 3
2.5 mm² × 3
4 mm² × 2 |
|---|--|

American Socket



WEBP1619610F

Technical Specifications الموصفات الفنية

- | | |
|---|--|
| <ul style="list-style-type: none"> ▶ Standards
Comply with SASO 2204(2003) ▶ Rating
15A 127V~ ▶ Ambient Temperature
-10°C – +40°C ▶ Representative Performance <ul style="list-style-type: none"> ·Electric strength
: 2,000V 1 min ·Operation test
: 15,000 times (30,000 movements) ·Temperature rise
: Test current 15A (2.5 mm²)
Not more than 35K (Terminals) | <ul style="list-style-type: none"> ▶ Terminal
Screw Terminal ▶ Applicable Wire
1.5 mm² - 4 mm²
15 AWG - 12 AWG ▶ Terminal Capacity
1.5 mm² × 3
2.5 mm² × 3
4 mm² × 2 |
|---|--|

EL Guard



WEB17419W

Technical Specifications الموصفات الفنية

- | | |
|---|--|
| <ul style="list-style-type: none"> ▶ Standards
Comply with
Socket: BS 1362-2 and IEC 60884-2-3
RCD: IEC 62640 ▶ Rating
Socket Outlet: 13A 220-240V
Rated Frequency: 50-60Hz
Rated Residual Operating Current 30mA
Rated Residual Making and Breaking Capacity 250A
Rated conditional short-circuit current 1500A
Rated Conditional residual short-circuit current 1500A ▶ Breaktime
300 ms or less (at rated residual operating current)
150ms or less (at 2X rated residual operating current)
40ms or less (at 5X rated residual operating current)
Rated Residual Non-Operating Current 15mA
Leakage Waveform : Type AC | <ul style="list-style-type: none"> Opening /Closing : 4,000 Times
(Opening 2,000/Closing 2,000) ▶ Ambient Temperature
-5°C – +40°C ▶ Representative Performance <ul style="list-style-type: none"> ·Electric strength : 2,000V 1 min ·Operation test :
Socket Outlet : 15,000 times (30,000 movements) ·Temperature rise :
Test current 20A (2.5mm²)
Not more than 52K (Terminals) ▶ Terminal
Pillar Terminal II ▶ Applicable Wire
1.5 mm² - 4 mm² Stranded
Diameter 1.38 mm - 2.25 mm |
|---|--|

FULL-COLOR WIDE SERIES BS-TYPE , A-TYPE
 FULL-COLOR WIDE SERIES Refina BS-TYPE , A-TYPE
 اآرى
Others



BS13A + USB



WEB11114

Technical Specifications الموصفات الفنية

- ▶ Standards: Comply with BS1363, BS5733, IEC62368-1, EN62368-1
- ▶ Rating: Socket Outlet: 13A 250V~ USB: 2.1A 5V
- ▶ Ambient Temperature: -5°C - +40°C]
- ▶ Representative Performance:
 - Electric strength : 1,500V 1 min
 - Operation test : Socket Outlet: 15,000 times (30,000 movements)
 - Temperature rise : Test current 20A (2.5 mm²) Not more than 47K (Terminals)
- ▶ Terminal: Pillar Terminal
- ▶ Applicable Wire: 2.5 mm² - 6.0 mm² / 14 AWG - 12 AWG
- ▶ Terminal Capacity: 2.5 mm² x 3, 4 mm² x 2, 6 mm² x 1

BS13A + USB



WEB111159W

Technical Specifications الموصفات الفنية

- ▶ Standards Comply with Socket: BS1362-2 and IEC 60884-2-3 USB: IEC 60950-1
- ▶ Rating Socket Outlet : 13A 250V~ USB Charger : DC 5V 2.0A
- ▶ Ambient Temperature -10°C - +40°C
- ▶ Representative Performance
 - Electric strength : 2,000V 1 min
 - Operation test : Socket Outlet : 15,000 times (30,000 movements) USB Charger : 10,000 times
 - Temperature rise : Test current 20A (2.5mm²) Not more than 52K (Terminals)
- ▶ Terminal Pillar Terminal II
- ▶ Applicable Wire 2.5 mm² - 4 mm² Stranded Diameter 1.78mm - 2.25mm

Cooker Control Unit



WEB111169W

Technical Specifications الموصفات الفنية

- ▶ Standards Comply with Socket: BS 1362-2 and IEC 60884-2-3 Switch: IEC 60669-1
- ▶ Rating Switch: 45A 250V~ Socket Outlet: 13A 250V~
- ▶ Ambient Temperature -10°C - +40°C
- ▶ Representative Performance
 - Electric strength : 1,500V 1 min
 - Operation test : Switch: 20,000 Operations Socket Outlet: 15,000 times (30,000 movements)
- ▶ Terminal Pillar Terminal
- ▶ Applicable Wire 4 mm² - 16 mm² Stranded [AWG] AWG 10 - AWG 6
- ▶ Temperature rise : Test current 51A (16 mm²) Not more than 45K (Terminals)

HDMI connector



WEBP42150F

Technical Specifications الموصفات الفنية

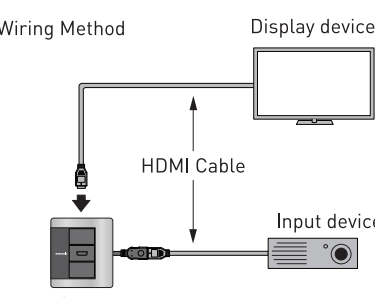
- ▶ Applicable Wire HDMI cable : Type A  Type A (standard)
- ▶ Wiring Method  Display device Input device HDMI Cable HDMI Connector

13A socket without Switch



WEBP13117W

Technical Specifications الموصفات الفنية

- ▶ Standards Comply with BS1363-2 and IEC60884-1
- ▶ Rating 13A 250V~
- ▶ Ambient Temperature -10°C - +40°C
- ▶ Representative Performance
 - Electric strength : 2,000V 1 min
 - Operation test : 15,000 times (30,000 movements)
 - Temperature rise : Test current 20A (2.5 mm²) Not more than 52K (Terminals)
- ▶ Terminal Pillar Terminal II
- ▶ Applicable Wire 1.5 mm² - 4 mm² 15 AWG - 12 AWG
- ▶ Terminal Capacity 1.5 mm² x 3 2.5 mm² x 3 4 mm² x 2

45A, 20A Cable outlet



WEB7010W

WEB7020W

Technical Specifications الموصفات الفنية

- ▶ Standards and Approvals Comply with BS5733
- ▶ Ambient Temperature -5°C - +40°C
- ▶ Representative Performance
 - Electric strength : 2,000V 1min
 - Temperature rise : WEC7010W : Test current 22A (4 mm²) WEB7020W : Test current 49.5A (6 mm²) Not more than 47K (Terminals)
- ▶ Terminal Pillar Terminal
- ▶ Applicable Wire WEC7010W Input/Output : 2.5 mm² - 6 mm² (Rigid Copper Wire) 1.5 mm² - 2.5 mm² (Flexible Electrical Wire) WEB7020W: Input/Output : 6 mm² - 10 mm² (Rigid Copper Wire) 4 mm² - 6 mm² (Flexible Electrical Wire)
- ▶ Terminal Capacity WEC7010W Input 2.5 mm², 4 mm² 6 mm², x 1 Output 1.5 mm², 2.5 mm², x 1 WEB7020W : Input 6 mm², 10 mm² Output 4 mm², 6 mm²