

يعزز تنسيق الألوان الدقيق والأنيق بيئات المعيشة

Subtle and stylish color coordination enhances living environments



FULL-COLOR
WIDE
SERIES
Refina

BS-TYPE

لوحة ألوان واسعة لتتناسب تمامًا مع التصميمات الداخلية لنمط الحياة.

**WIDE COLOR PALETTE
TO PERFECTLY MATCH
LIFESTYLE INTERIORS**

Luxurious appearance with wide color variations range enhances living spaces.



أحدث آلية تبديل مقاومة للحرارة وسهلة الاستخدام

**HEAT-RESISTANT,
EASY-TO-USE LATEST
SWITCH MECHANISM**

Simple switch mechanism made trouble-free.

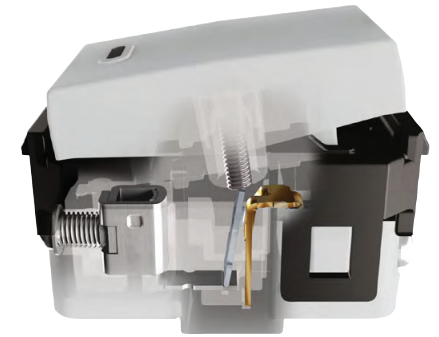

تضمن ميزات الموثوقية العالية السلامة

**HIGH RELIABILITY
FEATURES ENSURE
SAFETY**

Complies with requirements of the Saudi Arabian Standards Organization (SASO) & Emirates Quality Mark.



FLATIMA SERIES
BS-TYPE

FULL-COLOR WIDE SERIES
Refina BS-TYPE

FULL-COLOR WIDE SERIES
BS-TYPE

FULL-COLOR SERIES
BS-TYPE

FULL-COLOR WIDE SERIES Refina BS-TYPE

QUICK & SAFE Quick Connect Terminal II
 Solid Wire : 1.5-2.5mm²
 Stranded Wire : 1.5-2.5mm²

★ **Screw Terminal**
 Please check applicable wires in technical details.

مفاتيح كهربائية
 Switches

WEBP515117 □□□□
 1-Gang, 1-Device 1Way Switch,
 16AX 250V with Plate



★

WEBP525217 □□□□
 1-Gang, 2-Device 1Way Switch,
 16AX 250V with Plate



★

WEBP535317 □□□□ K
 1-Gang, 3-Device 1Way Switch,
 16AX 250V with Plate



★

WEBP515127 □□□□
 1-Gang 2Way Switch, 16AX 250V
 with Plate



★

WEBP525227 □□□□
 1-Gang, 2-Device 2Way Switch,
 16AX 250V with Plate



★

WEBP535327 □□□□ K
 1-Gang, 3-Device 2Way Switch,
 16AX 250V with Plate



★

WEBP545227 □□□□ **NEW**
 1-Gang, 4-Device 2Way Switch,
 10AX 250V with Plate



★

WNG5002H-791
 2Way Switch, 15AX 250V
WNG500207H-SA (Coming Soon)
 2Way Switch, 16AX 250V
WZB7831 □□□□ -P (Plate)
 1-Gang 1-Device



★

Combination Model number
WNBP5210630 □□□□

WNG5002H-791 X 2
 2Way Switch, 15AX 250V
WNG500207H-SA X 2 (Coming Soon)
 2Way Switch, 16AX 250V
WZB7832 □□□□ -P (Plate)
 1-Gang 2-Device



★

Combination Model number
WNBP5220630 □□□□

WNG5002H-791 X 3
 2Way Switch, 15AX 250V
WNG500207H-SA X 3 (Coming Soon)
 2Way Switch, 16AX 250V
WZB7833 □□□□ -P (Plate)
 1-Gang 3-Device



★

Combination Model number
WNBP5230630 □□□□

WNG5002H-791 X 4
 2Way Switch, 15AX 250V
WNG500209H-SA X 4 (Coming Soon)
 2Way Switch, 16AX 250V
WZB7834 □□□□ -P (Plate)
 2-Gang 4-Device



★

Combination Model number
WNBP5240630 □□□□

WNG5021HSP-7
 1Way Twin Switch, 10AX 250V
WZB7831 □□□□ -P (Plate)
 1-Gang 1-Device



★

Combination Model number
WNBP5101610M □□□□

*Stock Only

WNG5021HSP-7 X 2
 1Way Twin Switch, 10AX 250V
WZB7832 □□□□ -P (Plate)
 1-Gang 2-Device



★

Combination Model number
WNBP5141610M □□□□

*Stock Only

WNG5021HSP-7 X 4
 1Way Twin Switch, 10AX 250V
WZB7834 □□□□ -P (Plate)
 2-Gang 4-Device



★

Combination Model number
WNBP5181610M □□□□

*Stock Only

WNG5001H-791
 1Way Switch, 15AX 250V
WNG500107H-SA (Coming Soon)
 1Way Switch, 16AX 250V
WZB7831 □□□□ -P (Plate)
 1-Gang 1-Device



★

Combination Model number
WNBP5110630 □□□□

WNG5001H-791 X 2
 1Way Switch, 15AX 250V
WNG500107H-SA X 2 (Coming Soon)
 1Way Switch, 16AX 250V
WZB7832 □□□□ -P (Plate)
 1-Gang 2-Device



★

Combination Model number
WNBP5120630 □□□□

WNG5001H-791 X 3
 1Way Switch, 15AX 250V
WNG500107H-SA X 3 (Coming Soon)
 1Way Switch, 16AX 250V
WZB7833 □□□□ -P (Plate)
 1-Gang 3-Device



★

Combination Model number
WNBP5130630 □□□□

WNG5001H-791 X 4
 1Way Switch, 15AX 250V
WNG500107H-SA X 4 (Coming Soon)
 1Way Switch, 16AX 250V
WZB7834 □□□□ -P (Plate)
 2-Gang 4-Device



★

Combination Model number
WNBP5140630 □□□□

WEBP5513630 □□□□
 Intermediate Switch, 4Way, 16AX 250V



★

WEG5401 □□□□ -7-SP
 Push Button, 10A 250V
WEB7811 □□□□ (Plate)
 1-Gang 1-Device



★

Combination Model number
WEBP5113650 □□□□

WEG553272 □□□□
 20A 2Way SP Switch
WEB7811 □□□□ (Plate)
 1-Gang 1-Device



★

Combination Model number
WEBP5214730 □□□□

WEG55337 □□□□
 20A DP Switch with Indicator
WEB7811 □□□□ (Plate)
 1-Gang 1-Device



★

Combination Model number
WEBP5414600 □□□□

الوان متنوعة
 Variety of Colors



Metallic White
 MW □

Metallic Pearl White
 MWZ □

Metallic Gray
 MH □

Metallic Black
 MB □



Metallic Gold
 MY □





Metallic Brown
 MF □



Metallic Dark Brown
 MA □





FULL-COLOR WIDE SERIES Refina BS-TYPE

★ Screw Terminal
Please check applicable wires in technical details.





<p>WEBP5414630 □□□□</p> <p>20A DP Switch with Indicator "Water Heater" and Plate</p>  <p>★</p>	<p>WEBP52832 □□□□ -SP</p> <p>Shutter Switch with Plate</p>  <p>★</p>	<p>WNBP5428690 □□□□ K</p> <p>45A DP Switch with Indicator and 1-Gang Plate, Pillar Terminal</p>  <p>★</p> <p>WNBP5428690D □□□□ (old model)</p> <p>WBG5408699H 45A DP Switch with Indicator</p> <p>WZB7832 □□□□ -P (Plate) 1-Gang 2-Device</p>	<p>WNBP5448690 □□□□ K</p> <p>45A DP Switch with Indicator and 2-Gang Plate, Pillar Terminal</p>  <p>★</p> <p>WNBP5448690D □□□□ (old model)</p> <p>WBG5408699H 45A DP Switch with Indicator</p> <p>WZB7817 □□□□ -P (Plate) 2-Gang 2-Device</p>
--	--	--	--





<p>WEB1131 □□□□ K</p> <p>15A 250V 1-Gang Switched Round Pin Outlet with Plate</p>  <p>★</p>	<p>WNG1101-791H</p> <p>15A 127V 3Wire Grounding Socket</p> <p>WZB7831 □□□□ -P (Plate) 1-Gang 1-Device</p>  <p>★</p> <p>Combination Model number</p> <p>WNBP1619600 □□□□</p>	<p>WNG1101-791H X 2</p> <p>15A 127V 3Wire Grounding Socket</p> <p>WZB78322 □□□□ (Plate) 1-Gang 2-Device</p>  <p>★</p> <p>Combination Model number</p> <p>WNBP1629603 □□□□</p>	<p>WEG11517H</p> <p>15A 127V 3Wire Grounding Socket Outlet</p> <p>WEB7812 □□□□ (Plate) 1-Gang 2-Device</p>  <p>★</p> <p>Combination Model number</p> <p>WEBP1619610 □□□□</p>
---	---	---	--

<p>WEB7100 □□□□ NEW</p> <p>13A Fuse Connection Unit</p>  <p>★</p>	<p>WEB7101 □□□□ NEW</p> <p>13A Fuse Connection Unit with Indicator</p>  <p>★</p>	<p>WEB7103 □□□□ NEW</p> <p>13A Fuse Connection Unit with DP Switch and Indicator</p>  <p>★</p>
--	---	---





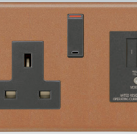

<p>WEG10817H</p> <p>16A 250V Universal Socket with Shutter</p> <p>WEG55317 □□□□ 1Way Switch 16AX 250V</p> <p>WEB7812 □□□□ (Plate) 1-Gang 2-Device</p>  <p>★</p> <p>Combination Model number</p> <p>WEGP5120632 □□□□</p>	<p>WEG10817H</p> <p>16A 250V Universal Socket with Shutter</p> <p>WEB7811 □□□□ (Plate) 1-Gang 1-Device</p>  <p>★</p> <p>Combination Model number</p> <p>WEBP1914610 □□□□</p>	<p>WEG10817H X 2</p> <p>16A 250V Universal Socket with Shutter</p> <p>WEB7812 □□□□ (Plate) 1-Gang 2-Device</p>  <p>★</p> <p>Combination Model number</p> <p>WEBP1924610 □□□□</p>	<p>WEG11817H</p> <p>16A 250V Grounding Universal Socket with Shutter</p> <p>WEB7812 □□□□ (Plate) 1-Gang 2-Device</p>  <p>★</p> <p>Combination Model number</p> <p>WEBP1814710 □□□□</p>
---	--	--	--

مقابس Socket Outlets

<p>WEBP13117 □□□□ NEW</p> <p>13A 250V 1-Gang Unswitched Socket Outlet with Plate</p>  <p>★</p>	<p>WEB11119 □□□□</p> <p>13A 250V 1-Gang DP Switched Socket Outlet with Plate</p>  <p>★</p> <p>WEB1111K □□□□ (old model) 13A 250V 1-Gang DP Switched Socket Outlet with Plate</p>	<p>WEB11129 □□□□</p> <p>13A 250V 2-Gang DP Switched Socket Outlet with Plate</p>  <p>★</p> <p>WEB1112K □□□□ (old model) 13A 250V 2-Gang DP Switched Socket Outlet with Plate</p>	<p>WEB11114 □□□□ NEW</p> <p>13A 250V Socket Outlet 1-gang, DP Switched with 1 Port USB Charger</p>  <p>★</p>
---	---	---	---

<p>WEG15827H</p> <p>16A 250V Grounding Universal Socket with Shutter</p> <p>WEB7813 □□□□ (Plate) 1-Gang 3-Device</p>  <p>★</p> <p>Combination Model number</p> <p>WEGP1824710 □□□□</p>	<p>WEB111169 □□□□</p> <p>Cooker Control Unit with Plate</p>  <p>★</p> <p>WEB11116 □□□□ (old model) Cooker Control Unit</p>	<p>WEB17419 □□□□</p> <p>13A 250V Socket Outlet Residual Current Device with Plate</p>  <p>★</p> <p>WEB1741 □□□□ (old model) Socket Outlet Residual Current Device with Plate</p>	<p>WEB111159 □□□□</p> <p>13A 250V Socket Outlet 1-Gang, DP Switched with 2-port USB Charger, and Plate</p>  <p>★</p> <p>WEB11115 □□□□ (old model) Socket Outlet 1-Gang, DP Switched with 2-port USB Charger</p>
--	---	---	--

الوان متنوعة Variety of Colors

						
Metallic White M W □	Metallic Pearl White M W Z	Metallic Gray M H □	Metallic Black M B □	Metallic Gold M Y □	Metallic Brown M F □	Metallic Dark Brown M A □

FULL-COLOR WIDE SERIES Refina BS-TYPE



اكسسورات
Accessories

<p>WEG2364H Telephone Socket 6P4C WEB7811 [] [] [] (Plate) 1-Gang 1-Device</p> <p>Combination Model number WEBP4519940 [] [] []</p>	<p>WEG2364H X 2 Telephone Socket 6P4C WEB7812 [] [] [] (Plate) 1-Gang 2-Device</p> <p>Combination Model number WEBP4529940 [] [] []</p>	<p>WEG2501-PH TV Socket DIN Type WEB7811 [] [] [] (Plate) 1-Gang 1-Device</p> <p>Combination Model number WEBP4719830 [] [] []</p>	<p>WEG2501-PH X 2 TV Socket DIN Type WEB7812 [] [] [] (Plate) 1-Gang 2-Device</p> <p>Combination Model number WEBP4729830 [] [] []</p>
<p>WEG2731H TV Socket F Type WEB7811 [] [] [] (Plate) 1-Gang 1-Device</p> <p>Combination Model number WEBP47194501 [] [] []</p> <p>*Stock Only</p>	<p>WEG2741H NEW Oblique TV Socket F Type WEB7811 [] [] [] (Plate) 1-Gang 1-Device</p> <p>Combination Model number WEBP47164501 [] [] []</p>	<p>WEG2731H X 2 TV Socket F Type WEB7812 [] [] [] (Plate) 1-Gang 2-Device</p> <p>Combination Model number WEBP47294501 [] [] []</p> <p>*Stock Only</p>	<p>WEG2364H Telephone Socket 6P4C WE2731H-8 TV Socket F Type WEB7812 [] [] [] (Plate) 1-Gang 2-Device</p> <p>Combination Model number WEBP45299471 [] [] []</p> <p>*Stock Only</p>
<p>WEG2488H-P Cat 5E Outlet WEB7811 [] [] [] (Plate) 1-Gang 1-Device</p> <p>Combination Model number WEBP4519980 [] [] []</p>	<p>WEG24886H-P Cat 6 Outlet WEB7811 [] [] [] (Plate) 1-Gang 1-Device</p> <p>Combination Model number WEBP4519680 [] [] []</p>	<p>WEG2364H Telephone Socket 6P4C WEG24886H-P Cat 6 Outlet WEB7812 [] [] [] (Plate) 1-Gang 2-Device</p> <p>Combination Model number WEBP4529682 [] [] []</p>	<p>WEB7010 NEW 1-Gang Cable Outlet with 20A Terminal Block</p> <p>★</p>

Dimmer Switches ديمر لتحديد شدة الاضاءة

<p>WEB7020 NEW 1-Gang Cable Outlet with 45A Terminal Block</p> <p>★</p>	<p>WEG578153H Dimmer Switch 500W 220-240V- 50/60Hz WEB7812 [] [] [] (Plate) 1-Gang 2-Device</p> <p>Combination Model number WEBP5781530 [] [] []</p>	<p>WEG57912H-P LED Dimmer Switch 200W (LED50W) 220-240V- 50/60Hz WEB7812 [] [] [] (Plate) 1-Gang 2-Device</p> <p>Combination Model number WEBP579120 [] [] []</p>	<p>WEG57915H-P NEW LED Dimmer Switch 240W(LED200W) 220-240V- 50/60Hz WEB7812 [] [] [] (Plate) 1-Gang 2-Device</p> <p>Combination Model number WEBP579150 [] [] []</p>
---	---	--	---

HDMI المقبس
HDMI Connector

WEG2021H **NEW**
HDMI Connector
WEB7811 [] [] [] -P
1-Gang 1-Device

Combination Model number
WEBP42150 [] [] []

شاحن USB
USB Charger

<p>WNF1071H8 1-port USB Charger (Gray) WZB7832 [] [] [] -P (Plate) 1-Gang 2-Device</p> <p>Combination Model number WNBP1426120D [] [] []</p>	<p>WNF1072H8 2-port USB Charger (Gray) WZB7832 [] [] [] -P (Plate) 1-Gang 2-Device</p> <p>Combination Model number WNBP1072D [] [] []</p>
---	--

WNBP1072D [] [] [] -1
WNF1072H8-1
(Vertical Type)

WEF1172H8K
2-port USB Charger (Gray)
WEB7812 [] [] [] (Plate)
1-Gang 2-Device

Combination Model number
WEBP1172D [] [] []

WEBP11721D [] [] []
WEF11721H8K
(Vertical Type)

الوان متنوعة
Variety of Colors

<p>Metallic White MW [] []</p>	<p>Metallic Pearl White MWZ [] [] []</p>	<p>Metallic Gray MH [] []</p>	<p>Metallic Black MB [] []</p>	<p>Metallic Gold MY [] []</p>	<p>Metallic Brown MF [] []</p>	<p>Metallic Dark Brown MA [] []</p>
--	---	---	--	---	--	---

FULL-COLOR WIDE SERIES BS-TYPE , A-TYPE
 FULL-COLOR WIDE SERIES Refina BS-TYPE , A-TYPE
 مفاتيح كهربائية 16 امبير
Switches 16AX

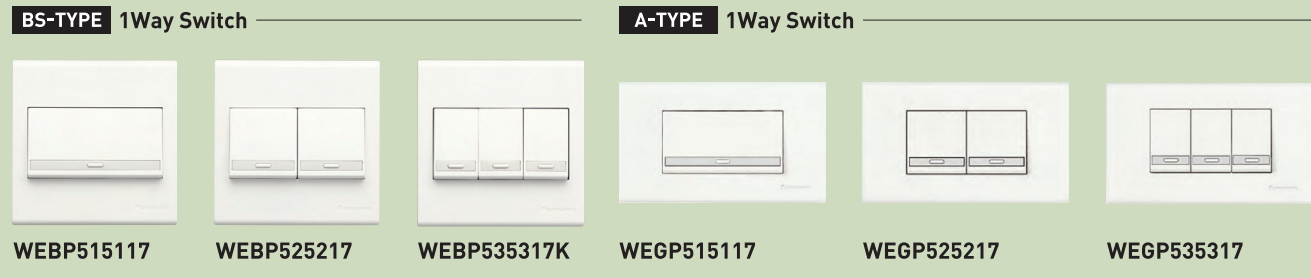

Technical Specifications الموصفات الفنية

- ▶ Standards
Comply with IEC60669-1
- ▶ Rating
16AX 250V~
- ▶ Ambient Temperature
-10°C – +40°C
- ▶ Representative Performance
 - Electric strength : 2,000V 1 min
 - Operation test : 40,000 Operations
 - Temperature rise : Test current 20A (2.5 mm²)
Not more than 45K (Terminals)
- ▶ Terminal
Pillar Terminal II
- ▶ Applicable Wire
1.5 mm² - 4 mm²
15 AWG - 12 AWG
- ▶ Terminal Capacity
1.5 mm² × 3
2.5 mm² × 2
4 mm² × 1

Features المميزات

Improved contact reliability through our design using proprietary technology.

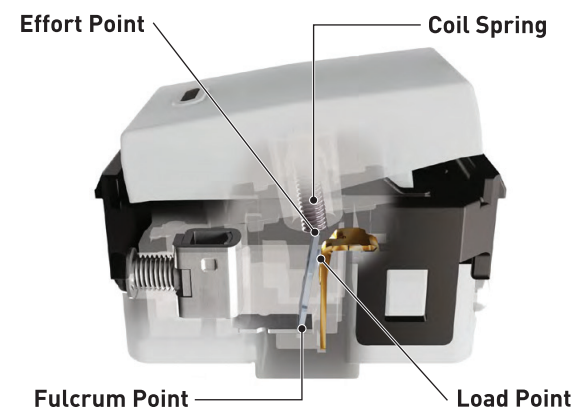

Coil Spring Reversal Method

Panasonic's proprietary coil spring reversal method, causes the pressure applied on the connector to be stable, so that it does not become very hot. By keeping the bound small, the production of arc energy is minimized.

- Because the damage is small, the contacts do not fuse easily, making them long lasting.
- Our products have cleared the On/Off testing for 40,000 operations required by IEC.

Urea Resin

The use of urea resin which is safer and more secure has led to improved fire resistance. It also has excellent tracking resistance which prevents electric shocks.

- Even when the product is wrongly used, the casing does not fuse. As such, it is fire proof and shock proof.
- It is resistant to fire caused by tracking on the surface of the socket, and the material itself does not melt easily.
- Since the material is highly insulated so that electricity does not pass through it, it is shock proof.

Pillar Terminal

- Built-in pillar terminal accommodates any wire configuration.
- 1 mm² - 4 mm²

Features المميزات

Urea Resin

Characteristics of Urea Resin

- Excellent arc resistance, arc tracking resistance, flame retardance, heat resistance, color fastness.
- Has good electrical performance and mechanical strength with excellent abrasion resistance.
- Difficult to scratch, and there is virtually no adherence of dust due to static electricity.
- Organic solvents and oily substances cannot permeate.

Enclosure Material Characteristics (reference)

	Urea	PBT	Polycarbonate
Tracking Performance	Excellent	Good	Poor
Heat Deformation	Good	Good	Fair
Self-Extinguishment	Good	Good	Good

Coil Spring Reversal Method

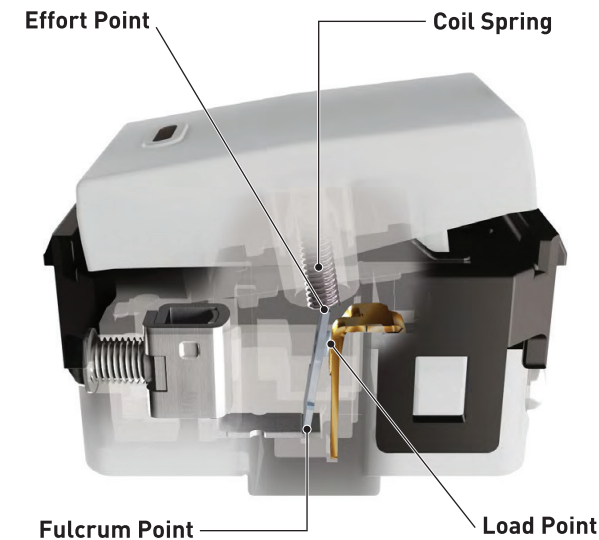

Bounce Performance Comparison

The Full-Color Series has a coil spring system to reduce arc energy generation, making it ideal for compact fluorescent lighting (CFL), inverter illumination and LED lighting.

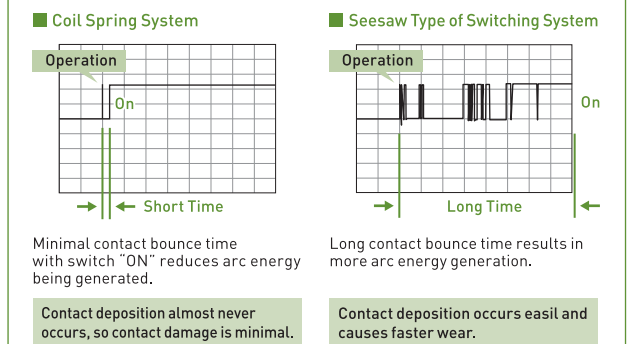

Terminal

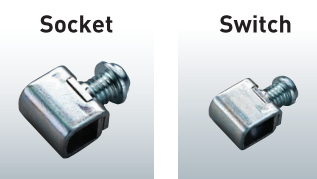

Flexible wire (class 5) also applicable

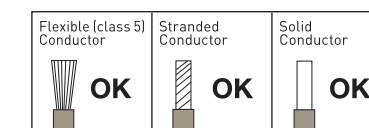

Rigid (Solid or Stranded) & Flexible (only class 5) Copper Conductor Type

TECHNICAL DETAILS تفاصيل تقنية

Dimensions الأبعاد

BS-TYPE 1Way Switch

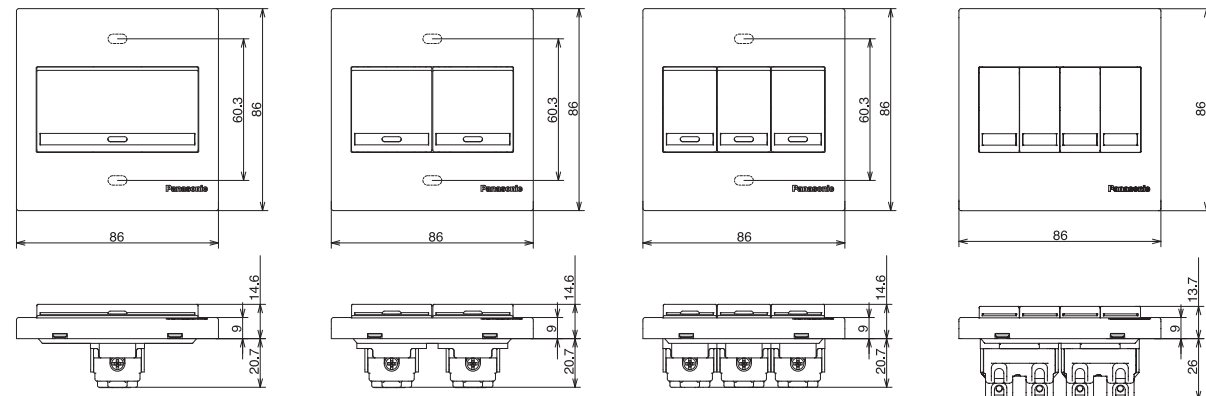

WEBP515117

WEBP525217

WEBP535317K

WEBP545227

*BS-TYPE : with screws for insert.

➔ See Page 106 for detail spec

A-TYPE 1Way Switch

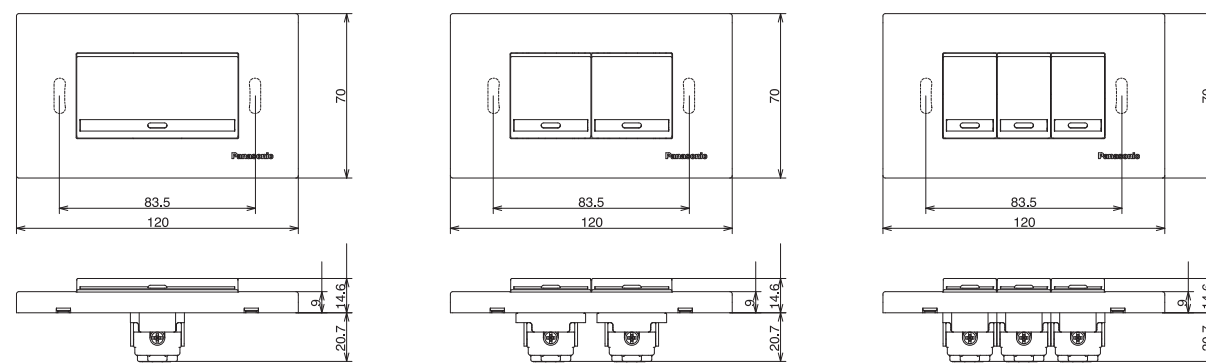

WEGP515117

WEGP525217

WEGP535317

Applicable Box صندوق قابل للتطبيق

BS-TYPE



► Dimensions
Plate : 86 x 86 mm
Box : 72 x 72 mm
Fixing Center : 60.3 mm



► Dimensions
Plate : 86 x 146 mm
Box : 72 x 132 mm
Fixing Center : 120.6 mm

A-TYPE

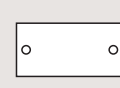

► Dimensions
Plate : 70 x 120 mm
Box : 51 x 102 mm
Fixing Center : 83.5 mm

FULL-COLOR WIDE SERIES BS-TYPE , A-TYPE FULL-COLOR WIDE SERIES Refina BS-TYPE , A-TYPE مفاتيح كهربائية 20 أمبير Switches 20A



BS-TYPE DP Switch with Indicator



WEG55337
WEB7811W
WEGP5414600F

A-TYPE DP Switch with Indicator



WEG55337
WEG6801WK-P
WEGP5414600F

Technical Specifications الموصفات الفنية

- Standards
Comply with IEC60669-1
- Rating
20A 250V~
- Ambient Temperature
-10°C – +40°C
- Representative Performance
 - Electric strength : 2,000V 1 min
 - Operation test : 10,000 Operations
 - Temperature rise : Test current 25A (4 mm²)
Not more than 45K (Terminals)
- Terminal
Pillar Terminal II
- Applicable Wire
2.5 mm² - 6 mm²
13 AWG - 10 AWG
- Terminal Capacity
2.5 mm² × 2
4 mm² × 1
6 mm² × 1

Features المميزات

- Switching mechanism uses a coil spring system for a longer service life.
- Made with flame-retardant and heat-resistant urea resin.
- Conductive section uses heat-resistant copper with superior anticorrosion property and conductivity for long-term stable, reliable performance.
- Accepts wires : 2.5 mm² - 6 mm² solid wire to flexible wire (class 5).

Dimensions الأبعاد

BS-TYPE DP Switch with Indicator

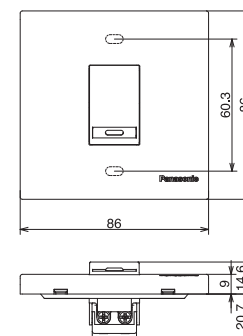

A-TYPE DP Switch with Indicator

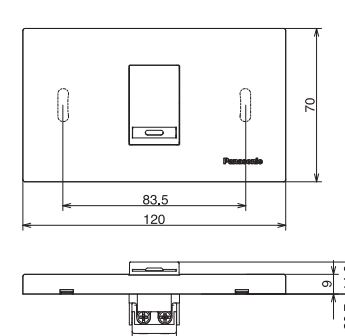

*BS-TYPE : M3.5 mounting screws included.

FULL-COLOR WIDE SERIES BS-TYPE, A-TYPE
 FULL-COLOR WIDE SERIES Refina BS-TYPE, A-TYPE
 مفاتيح كهربائية 45A
Switches 45A



BS-TYPE DP Switch with Indicator

OLD MODEL
WBG5408699W
WZB7832WK -1
 WNB5428690F
 NEW MODEL
WNB5428690FK



OLD MODEL
WBG5408699W
WZB7817W
 WNB5448690F
 NEW MODEL
WNB5448690FK

A-TYPE DP Switch with Indicator

OLD MODEL
WBG5408699W
WN3020W-P, WZB7843W
 WNGP5438693F
 NEW MODEL
WNGP5438693FK



FULL-COLOR WIDE SERIES BS-TYPE, A-TYPE
 FULL-COLOR WIDE SERIES Refina BS-TYPE, A-TYPE
 ديمر لتحديد شدة الاضاءة
Dimmer Switches



BS-TYPE 500W (Low Voltage)

WEG578153
WEB7812W
 WEBP5781530F



BS-TYPE LED Dimmer

WEG57912-P
WEB7812W
 WEBP579120F



WEG57915-P
WEB7812W
 WEBP579150F



Technical Specifications الموصفات الفنية

- Standards
Comply BS EN 60669-1
- Rating
45A 250V ~ (Resistive)
Motor Full load current of 25A or less,
power factor of 0.8 or more
- Ambient Temperature
-10°C – +40°C
- Representative Performance
·Electric strength : 1,500V 1 min
·Operation test : 10,000 operations
·Temperature rise : Test current 51A (16 mm²)
Not more than 45K (Terminals)
- Terminal
Pillar Terminal
- Applicable Wire
[Solid] 4 mm²
[Stranded] 4 mm² - 16 mm²
[AWG] AWG 10 - AWG 6
- Terminal Capacity
4 mm² × 2
6 mm² × 2
10 mm² × 1
16 mm² × 1

Features المميزات

- High -capacity silver contact for longer life.
- Made with flame-retardant and heat-resistant melamine phenol/urea resins.
- Conductive section uses heat-resistant copper with superior anticorrosion property and conductivity for long-term stable, reliable performance.
- Built-in lighted indicator shows On/Off status.
- Normal gap double-pole switch (minimum contact gap : 3 mm) construction ensures safe load shut-off.
- Double Earth Terminal.

Dimensions الأبعاد

BS-TYPE DP Switch with Indicator

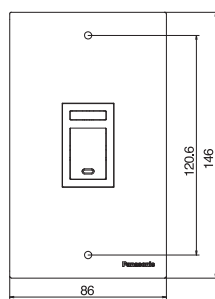
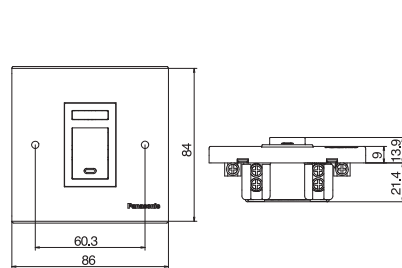

A-TYPE DP Switch with Indicator

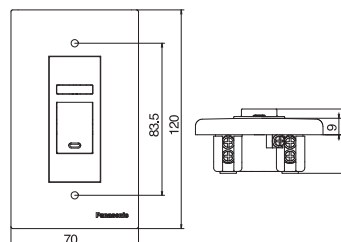

*BS-TYPE : M3.5 mounting screws included.

WEG578153

- Rating : 220V-240V~ 500W
- Ambient Temperature : 0°C – +35°C
- Terminal : Screw Terminal
- Applicable Wire : 1 mm²- 2.5 mm²

WEBP579120F / WEBP579150F

- Rating : 220V-240V- 50/60Hz
- LED 50W(WEBP579120F)
- LED200W(WEBP5709150F)
- Ambient Temperature:0°C - 35°C
- Terminal : Pillar (WEBP579120F)
Screw(WEBP579150F)
- Applicable Wire: 1mm²- 2.5mm²(WEBP579120F)
1mm²- 4mm²(WEBP579150F)

Features المميزات

WEG578153

- Applicable Wires : 1 mm² - 2.5 mm²
- Compatible with 500VA copper/steel and step-down transformers.
- Applicable for low-voltage halogen lamp use.
- Applicable for 500W incandescent lamp.

WEBP579120F / WEBP579150F

- Applicable incandescent lamps & low voltage halogen lamps & LED bulbs
- Chandelier lamp Silica lamp Clear lamp Hi-beam lamp
 - Halogen lamp LED dimmable bulb
 - When using low voltage halogen lamps, requires an applicable transformer to convert voltage from 220 V - 240 V to 12 V.
 - The brightness when dimmed is different depending on the LED bulb types and Brand.
 - When the knob is lower limit, brightness is different depending on the LED bulb types and Brand.
 - Be sure to use a light bulb with a built-in fuse.
Not doing so may result in damage to the dimmer switch when the light bulb burns out.

*Those products can't operate ventilating / ceiling fan.

Dimensions الأبعاد

BS-TYPE 500W (Low Voltage)

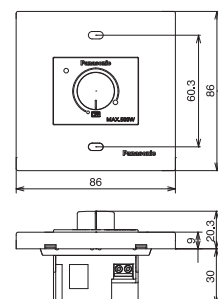

BS-TYPE LED Dimmer

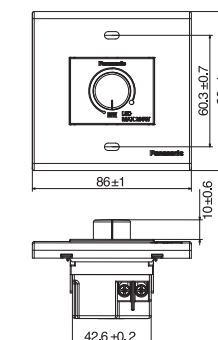
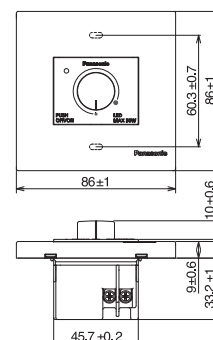

*BS-TYPE : M3.5 mounting screws included.

FULL-COLOR WIDE SERIES BS-TYPE
FULL-COLOR WIDE SERIES Refina BS-TYPE
مقابس
Socket Outlets



BS-TYPE Switched Socket

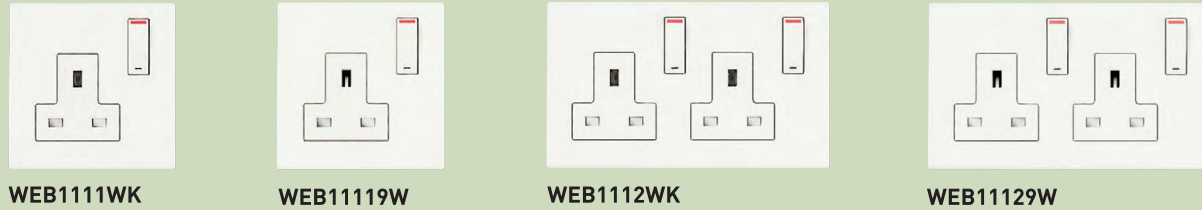

FULL-COLOR WIDE SERIES BS-TYPE, A-TYPE
FULL-COLOR WIDE SERIES Refina BS-TYPE, A-TYPE
اكسسورات
Accessories - Television

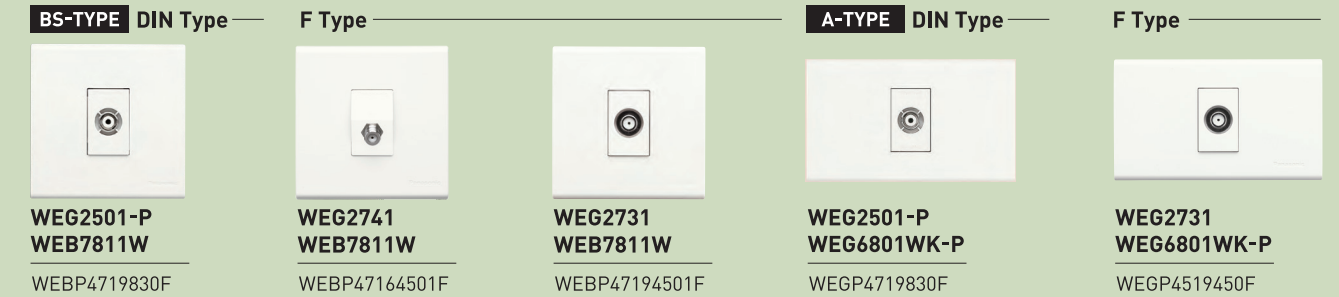

Technical Specifications الموصفات الفنية

- Standards: Comply with BS1363-2 and IEC60884-1
- Rating: 13A 250V~
- Ambient Temperature: -10°C – +40°C
- Representative Performance:
 - Electric strength : 2,000V 1 min
 - Operation test : 15,000 times (30,000 movements)
 - Temperature rise : Test current 20A (2.5 mm²) Not more than 52K (Terminals)
- Terminal: Pillar Terminal II
- Applicable Wire: 1.5 mm² - 4 mm²
- Terminal Capacity:
 - 1.5 mm² × 3
 - 2.5 mm² × 3
 - 4 mm² × 2

Features المميزات

- Socket Outlet with a double-pole switch completely isolates load from power supply.
- Socket Outlet housing uses flame-retardant and heat-resistant urea resin with high anti-tracking properties.
- Accepts wires : 1.5 mm² - 4 mm² solid wire to flexible wire.
- Both socket and switch parts made for enough switching capability.
- Included safety shutter prevents kids from tampering with switch.

Dimensions الأبعاد

BS-TYPE Switched Socket

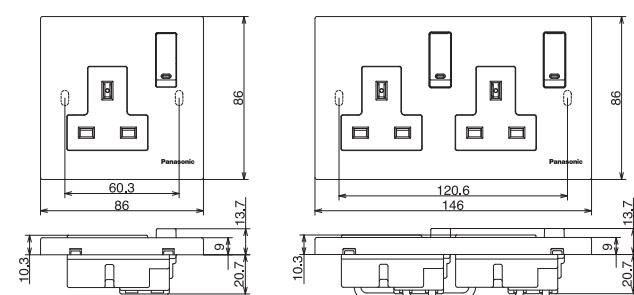

*BS-TYPE : M3.5 mounting screws included.

Applicable Box صندوق قابل للتطبيق

BS-TYPE

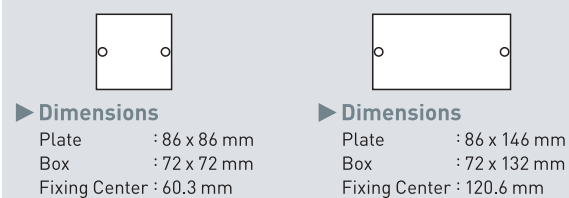

Technical Specifications الموصفات الفنية

DIN Type

- Connector Type (Outlet) : DIN Type
- Terminal: Screw Terminal (Only coaxial core isn't screw terminal type)
- Impedance Input, Outlet : 75Ω
- Applicable Cable: Coaxial Cable Characteristic Impedance 75Ω type : 5C - 2V, 3C - 2V

F Type

- Connector Type (Outlet): F type
- Terminal: Screw Terminal (Only coaxial core isn't screw terminal type)
- Impedance Input, Outlet : 75Ω
- Applicable Cable: Coaxial Cable Characteristic Impedance 75Ω type : S-5C-FB

Features المميزات

“Easy Connect” terminal for direct insertion of coaxial cable core.
Insert fully and tighten clamp.

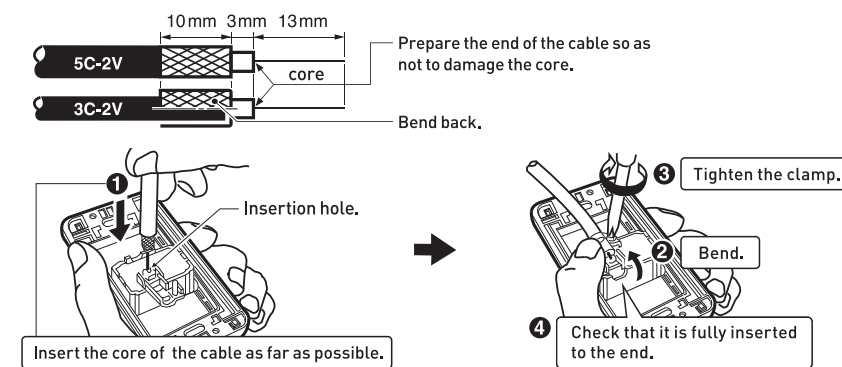

Dimensions الأبعاد

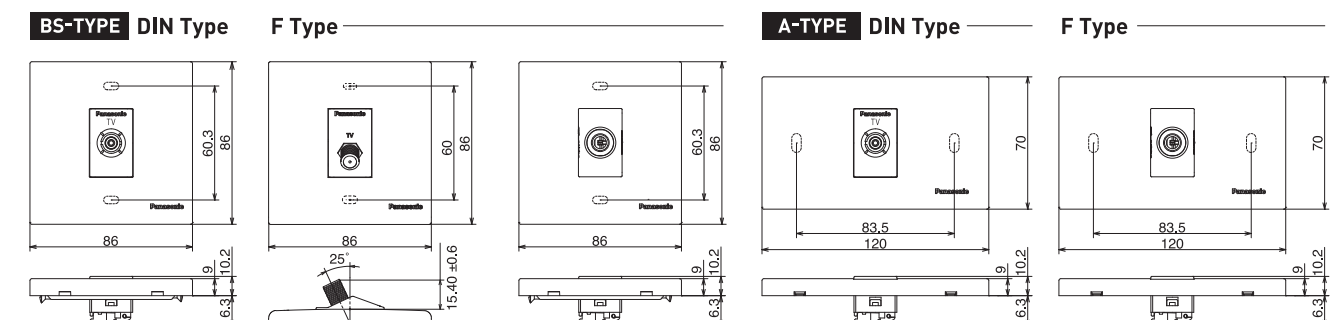

*BS-TYPE : M3.5 mounting screws included.

FULL-COLOR WIDE SERIES BS-TYPE , A-TYPE
 FULL-COLOR WIDE SERIES Refina BS-TYPE , A-TYPE
 اكسسورات هاتف
Accessories - Telephone



BS-TYPE 6P4C		A-TYPE 6P4C	
WEG2364 WEB7811W WEBP4519940F	WEG2364 WEB7812W WEBP4529940F	WEG2364 WEG6801WK-P WEGP4519940F	WEG2364 WEG6802WK-P WEGP4529940F

FULL-COLOR WIDE SERIES BS-TYPE , A-TYPE
 FULL-COLOR WIDE SERIES Refina BS-TYPE , A-TYPE
 اكسسورات انترنت
Accessories - LAN



BS-TYPE Category 5e , Category 6		A-TYPE Category 5e Category 6		
WEG2488-P WEB7811W WEBP4519980F	WEG24886-P WEB7811W WEBP4519680F	WEG2488-P WEG6801WK-P WEGP4519980F	WEG24886-P WEG6801WK-P WEGP4519680F	WEG24886-P WEG6802WK-P WEGP4529680F

Technical Specifications الموصفات الفنية

- ▶ Connector Type
Miniature Modular Jack, 6 position with 4-contacts, specified in TIA-1096-A (Previously in FCC part 68)
- ▶ Terminal
Quick Connect Terminal (Screwless Connection)
- ▶ Applicable Wire
Paired quad-type PVC indoor cable : Core wire to be 0.4 mm, 0.5 mm, 0.65 mm, in diameter (solid copper only)
2-pair Business-phone indoor cable : Core wire to be 0.4 mm, 0.5 mm, 0.65 mm, in diameter (solid copper only)

Features المميزات

- Quick Connect Terminal increases connection reliability.
- Quick Connect Terminal for easy connection.
- Simple Connection
Just insert cable into the terminal hole.
- Easy Cable Disconnection
Push removal button while pulling out cable.

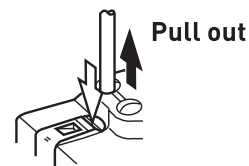
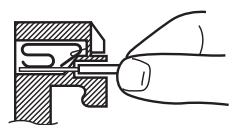

Dimensions الأبعاد

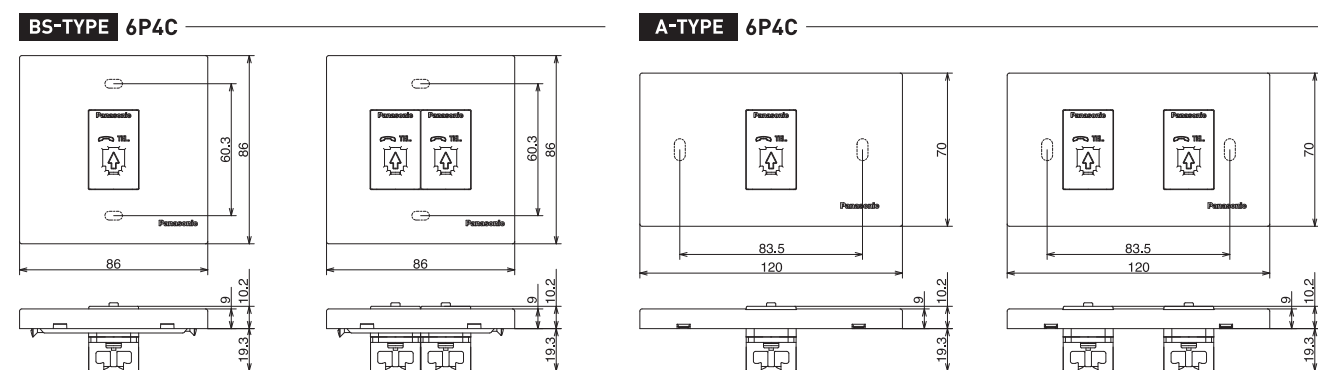

*BS-TYPE : M3.5 mounting screws included.

Technical Specifications الموصفات الفنية

- ▶ Connector Type
"8-way unshielded fixed connector (miniature 8-position modular jack)" specified in IEC 60603-7
- ▶ Terminal
IDC connection
- ▶ Applicable Cable
WEG2488 : 4-pair UTP cable, Category 5e
Conductor : solid copper wire, 24 AWG - 22 AWG (diameter : 0.5 mm-0.65 mm)
or stranded copper wire, 24 AWG
WEG24886 : 4-pair UTP cable, Category 6
Conductor : solid copper wire, 24 AWG - 22 AWG (diameter : 0.5 mm-0.65 mm)

Features المميزات

- 1 It's not necessary to use special wiring tool.**
2-way connection
Toolless: Cut the excess wires with nippers after connection.
Using wiring tool: Excess wires can be cut with the blade edge of the tool.
- 2 No need to untwist the wires.**
No need to untwist the wires to setting on the slots. Minimum untwisting retains uniform installation quality and transmission performance.

Pin/Pair assignment

T568A		T568B (Optional)	
Pair 2	Pair 3	Pair 1	Pair 4
Pair 3	Pair 1	Pair 2	Pair 4
1	2	3	4
5	6	7	8

Pair	Color	Pin No.	
		T568A	T568B
1	W/BL	5	5
	BL	4	4
2	W/O	3	1
	O	6	2
3	W/G	1	3
	G	2	4
4	W/BR	7	7
	BR	8	8

Dimensions الأبعاد

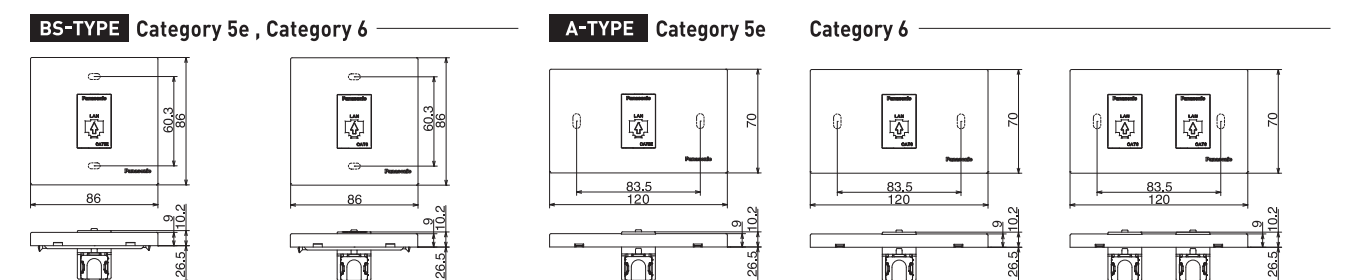

*BS-TYPE : M3.5 mounting screws included.

FULL-COLOR WIDE SERIES BS-TYPE , A-TYPE
 FULL-COLOR WIDE SERIES Refina BS-TYPE , A-TYPE
 اُخري
Others



4G Switch



WEBP545227

Technical Specifications الموصفات الفنية

- | | |
|---|---|
| <ul style="list-style-type: none"> ▶ Standards
Comply with IEC60669-1 ▶ Rating
10AX 250V~ ▶ Ambient Temperature
-10°C – +40°C ▶ Representative Performance <ul style="list-style-type: none"> ·Electric strength
: 2,000V 1 min ·Operation test
: 40,000 Operations ·Temperature rise
: Test current 20A (2.5 mm²)
Not more than 45K (Terminals) | <ul style="list-style-type: none"> ▶ Terminal
Screw Terminal ▶ Applicable Wire
1.0 mm² - 2.5 mm² ▶ Terminal Capacity
1.5 mm² × 1
3.5 mm² × 1
14 AWG × 1
12 AWG × 1 |
|---|---|

Push Button



WEBP5113650F

Technical Specifications الموصفات الفنية

- | | |
|---|--|
| <ul style="list-style-type: none"> ▶ Standards
Comply with IEC60669-1 ▶ Rating
10A 250V ~ ▶ Ambient Temperature
-10°C – +40°C ▶ Representative Performance <ul style="list-style-type: none"> ·Electric strength
: 2,000V 1 min ·Operation test
: 40,000 Operations ·Temperature rise
: Test current 13.5A (2.5 mm²)
Not more than 45K (Terminals) | <ul style="list-style-type: none"> ▶ Terminal
Screw Terminal ▶ Applicable Wire
1 mm² - 2.5 mm² ▶ Terminal Capacity
1 mm² × 1
1.5 mm² × 1
2.5 mm² × 1 |
|---|--|
- *Supply terminal has 2 terminal holes.

Universal Socket



WEBP1914610F

Technical Specifications الموصفات الفنية

- | | |
|---|--|
| <ul style="list-style-type: none"> ▶ Standards
Comply with IEC60884-1 ▶ Rating
16A 250V~ ▶ Ambient Temperature
-10°C – +40°C ▶ Representative Performance <ul style="list-style-type: none"> ·Electric strength
: 2,000V 1 min ·Operation test
: 5,000 times (10,000 movements) ·Temperature rise
: Test current 22A (2.5 mm²)
Not more than 45K (Terminals) | <ul style="list-style-type: none"> ▶ Terminal
Screw Terminal ▶ Applicable Wire
1.5 mm² - 4 mm²
15 AWG - 12 AWG ▶ Terminal Capacity
1.5 mm² × 3
2.5 mm² × 3
4 mm² × 2 |
|---|--|

15A 3Pin Socket

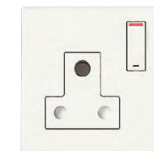

WEB1131WK

Technical Specifications الموصفات الفنية

- | | |
|---|--|
| <ul style="list-style-type: none"> ▶ Standards
Comply with BS546 ▶ Rating
15A 250V~ ▶ Ambient Temperature
-10°C – +40°C ▶ Representative Performance <ul style="list-style-type: none"> ·Electric strength
: 1,500V 1 min ·Operation test
: 15,000 times (30,000 movements) ·Temperature rise
: Test current 15A (2.5 mm²)
Not more than 35K (Terminals) | <ul style="list-style-type: none"> ▶ Terminal
Screw Terminal ▶ Applicable Wire
2.5 mm² - 4 mm² ▶ Terminal Capacity
1.5 mm² × 3
2.5 mm² × 3
4 mm² × 2 |
|---|--|

American Socket



WEBP1619610F

Technical Specifications الموصفات الفنية

- | | |
|---|--|
| <ul style="list-style-type: none"> ▶ Standards
Comply with SASO 2204(2003) ▶ Rating
15A 127V~ ▶ Ambient Temperature
-10°C – +40°C ▶ Representative Performance <ul style="list-style-type: none"> ·Electric strength
: 2,000V 1 min ·Operation test
: 15,000 times (30,000 movements) ·Temperature rise
: Test current 15A (2.5 mm²)
Not more than 35K (Terminals) | <ul style="list-style-type: none"> ▶ Terminal
Screw Terminal ▶ Applicable Wire
1.5 mm² - 4 mm²
15 AWG - 12 AWG ▶ Terminal Capacity
1.5 mm² × 3
2.5 mm² × 3
4 mm² × 2 |
|---|--|

EL Guard



WEB17419W

Technical Specifications الموصفات الفنية

- | | |
|---|--|
| <ul style="list-style-type: none"> ▶ Standards
Comply with
Socket: BS 1362-2 and IEC 60884-2-3
RCD: IEC 62640 ▶ Rating
Socket Outlet: 13A 220-240V
Rated Frequency: 50-60Hz
Rated Residual Operating Current 30mA
Rated Residual Making and Breaking Capacity 250A
Rated conditional short-circuit current 1500A
Rated Conditional residual short-circuit current 1500A ▶ Breaktime
300 ms or less (at rated residual operating current)
150ms or less (at 2X rated residual operating current)
40ms or less (at 5X rated residual operating current)
Rated Residual Non-Operating Current 15mA
Leakage Waveform : Type AC | <ul style="list-style-type: none"> Opening /Closing : 4,000 Times
(Opening 2,000/Closing 2,000) ▶ Ambient Temperature
-5°C – +40°C ▶ Representative Performance <ul style="list-style-type: none"> ·Electric strength : 2,000V 1 min ·Operation test :
Socket Outlet : 15,000 times (30,000 movements) ·Temperature rise :
Test current 20A (2.5mm²)
Not more than 52K (Terminals) ▶ Terminal
Pillar Terminal II ▶ Applicable Wire
1.5 mm² - 4 mm² Stranded
Diameter 1.38 mm - 2.25 mm |
|---|--|

FULL-COLOR WIDE SERIES BS-TYPE , A-TYPE
 FULL-COLOR WIDE SERIES Refina BS-TYPE , A-TYPE
 اآرى
Others



BS13A + USB



WEB11114

Technical Specifications الموصفات الفنية

- ▶ Standards: Comply with BS1363, BS5733, IEC62368-1, EN62368-1
- ▶ Rating: Socket Outlet: 13A 250V~ USB: 2.1A 5V
- ▶ Ambient Temperature: -5°C - +40°C]
- ▶ Representative Performance:
 - Electric strength : 1,500V 1 min
 - Operation test : Socket Outlet: 15,000 times (30,000 movements)
 - Temperature rise : Test current 20A (2.5 mm²) Not more than 47K (Terminals)
- ▶ Terminal: Pillar Terminal
- ▶ Applicable Wire: 2.5 mm² - 6.0 mm² / 14 AWG - 12 AWG
- ▶ Terminal Capacity: 2.5 mm² x 3, 4 mm² x 2, 6 mm² x 1

BS13A + USB



WEB111159W

Technical Specifications الموصفات الفنية

- ▶ Standards Comply with Socket: BS1362-2 and IEC 60884-2-3 USB: IEC 60950-1
- ▶ Rating Socket Outlet : 13A 250V~ USB Charger : DC 5V 2.0A
- ▶ Ambient Temperature -10°C - +40°C
- ▶ Representative Performance
 - Electric strength : 2,000V 1 min
 - Operation test : Socket Outlet : 15,000 times (30,000 movements) USB Charger : 10,000 times
 - Temperature rise : Test current 20A (2.5mm²) Not more than 52K (Terminals)
- ▶ Terminal Pillar Terminal II
- ▶ Applicable Wire 2.5 mm² - 4 mm² Stranded Diameter 1.78mm - 2.25mm

Cooker Control Unit



WEB111169W

Technical Specifications الموصفات الفنية

- ▶ Standards Comply with Socket: BS 1362-2 and IEC 60884-2-3 Switch: IEC 60669-1
- ▶ Rating Switch: 45A 250V~ Socket Outlet: 13A 250V~
- ▶ Ambient Temperature -10°C - +40°C
- ▶ Representative Performance
 - Electric strength : 1,500V 1 min
 - Operation test : Switch: 20,000 Operations Socket Outlet: 15,000 times (30,000 movements)
- ▶ Temperature rise : Test current 51A (16 mm²) Not more than 45K (Terminals)
- ▶ Terminal Pillar Terminal
- ▶ Applicable Wire 4 mm² - 16 mm² Stranded [AWG] AWG 10 - AWG 6

HDMI connector



WEBP42150F

Technical Specifications الموصفات الفنية

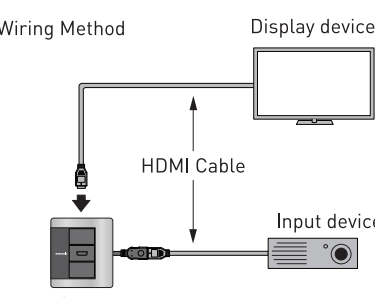
- ▶ Applicable Wire HDMI cable : Type A 
- ▶ Wiring Method 

13A socket without Switch



WEBP13117W

Technical Specifications الموصفات الفنية

- ▶ Standards Comply with BS1363-2 and IEC60884-1
- ▶ Rating 13A 250V~
- ▶ Ambient Temperature -10°C - +40°C
- ▶ Representative Performance
 - Electric strength : 2,000V 1 min
 - Operation test : 15,000 times (30,000 movements)
 - Temperature rise : Test current 20A (2.5 mm²) Not more than 52K (Terminals)
- ▶ Terminal Pillar Terminal II
- ▶ Applicable Wire 1.5 mm² - 4 mm² 15 AWG - 12 AWG
- ▶ Terminal Capacity 1.5 mm² x 3 2.5 mm² x 3 4 mm² x 2

45A, 20A Cable outlet



WEB7010W

WEB7020W

Technical Specifications الموصفات الفنية

- ▶ Standards and Approvals Comply with BS5733
- ▶ Ambient Temperature -5°C - +40°C
- ▶ Representative Performance
 - Electric strength : 2,000V 1min
 - Temperature rise : WEC7010W : Test current 22A (4 mm²) WEB7020W : Test current 49.5A (6 mm²) Not more than 47K (Terminals)
- ▶ Terminal Pillar Terminal
- ▶ Applicable Wire WEC7010W Input/Output : 2.5 mm² - 6 mm² (Rigid Copper Wire) 1.5 mm² - 2.5 mm² (Flexible Electrical Wire) WEB7020W: Input/Output : 6 mm² - 10 mm² (Rigid Copper Wire) 4 mm² - 6 mm² (Flexible Electrical Wire)
- ▶ Terminal Capacity WEC7010W Input 2.5 mm², 4 mm² 6 mm², x 1 Output 1.5 mm², 2.5 mm², x 1 WEB7020W : Input 6 mm², 10 mm² Output 4 mm², 6 mm²